

# martek<sup>®</sup>



*Denizlerde Kılavuzunuz...  
Your guide in the seas ...*

*Denizlerde kılavuzunuz...*  
*Your guide in the seas ...*



**martek<sup>®</sup>**

# martek®

Can Yelekleri	02-03	<i>Life Jackets</i>
Yüzdürme Yardımcıları	04	<i>Buoyancy Aids</i>
Neopren Darbe Yeleği	05	<i>Impact Vest</i>
Yüzdürücü Ceket, Denizci Ceket	05	<i>Flotation jacket, Sailor jacket</i>
Can Simidi, Nal Simidi	06	<i>Life Buoy And Horseshoe Life Buoy</i>
Işıklı Şamandıra	06	<i>Floating Life Buoy Lights</i>
Kurtarma Aparatları	07	<i>Rescue Equipments</i>
Balık Çiftliği Çözümleri	08	<i>Fish Farm Solutions</i>
Kuş Ağı Kuleleri	09	<i>Net Towers</i>
Modüler Balık Kafesleri	10	<i>Modular Fish Farming Cages</i>
Midye Çiftliği Çözümleri	11	<i>Mussel Farm Solutions</i>
Poliyeten Tanklar	12-15	<i>Polyethylene Tanks</i>
Şamandıralar	16-21	<i>Buoys</i>
Yüzdürücü Keleççeler	22	<i>Floating Clamps</i>
Usturmaçalar	23	<i>Fenders</i>
Bariyer-Kulvar Şamandıraları	24	<i>Lane Markers &amp; Barrier Floats</i>
Poliyeten Tekneler	25	<i>Polyethylene Boats</i>
Palamar Şamandıraları	26	<i>Mooring Buoys</i>
IALA Şamandıra Ø 4000	26	<i>IALA Buoyage System Ø 4000</i>
IALA Şamandıra Ø 3000	27	<i>IALA Buoyage System Ø 3000</i>
IALA Şamandıra Ø 2500	28	<i>IALA Buoyage System Ø 2500</i>
IALA Şamandıra Ø 2200	29	<i>IALA Buoyage System Ø 2200</i>
IALA Şamandıra Ø 1750	30	<i>IALA Buoyage System Ø 1750</i>
IALA Şamandıra Ø 1500	30	<i>IALA Buoyage System Ø 1500</i>
IALA Şamandıra Ø 1350	31	<i>IALA Buoyage System Ø 1350</i>
IALA Şamandıra Ø 1250	31	<i>IALA Buoyage System Ø 1250</i>
Modüler Fener Kulesi	32	<i>Modular Onshore Pe Tower And Mast</i>
Direk Tipi Şamandıra	33	<i>Pillar/Spar Buoy</i>
Yüzer iskeleler	34-35	<i>Floating Dock Systems</i>
Bot ve jetski park platformu	35	<i>Boat and jet ski parking platform</i>



CE 100  
EN ISO 12402-4

## 100N CAN YELEKLERİ / LIFE JACKETS

Yüzmeyi bilen ve bilmeyenlerin yakın sularda kullanımı için tasarlanmıştır. (EN ISO 12402-4)'e göre CE onaylıdır. İç kısmı kapalı hücre polietilen levhalardan oluşmaktadır. Yüksek görüş kabiliyetli oranj renkte kumaştan imal edilmiştir. Reflektörler SOLAS'a uygundur. Bel kayışı toka ile güçlendirilmiştir. Standartlara uygun kolay monte edilebilir düdüğü ve can yeleği ışığı için yeri mevcuttur.

*100N Life jackets are designed for swimmers and non-swimmers to use in sheltered waters. Approved to the European standards for 100N life jackets, ISO 12402-4. Buoyancy is provided by closed cell polyethylene foams. High visible orange colour fabric. Strap is fastened with buckle. Place for Life jacket Light.*



### VEST-100

#### YETİŞKİN CAN YELEĞİ / ADULT LIFE JACKET

Reflektörler Solas'a uygun 100 cm<sup>2</sup> dir. Bel kayışı toka ile güçlendirilmiştir ve bacak arasından geçen tokası ile maksimum korunması sağlanmıştır.

*The Life jackets are equipped with reflective Solas type 100 cm<sup>2</sup> tape strips, zip closure, hem tightening drawstring, a signalling whistle and with 100 newtons of buoyancy.*



### 100N

#### ÇOCUK CAN YELEĞİ / CHILDREN'S LIFE JACKET

Suyun içerisinde kullanıcının kafasını kavrarak güç harcamadan sabit kalmasına olanak sağlar.

Bel kayışı toka ile güçlendirilmiştir. Bacak arasından geçen tokası ile küçük yaştaki kullanıcıların tehlike anında maksimum korunması sağlanmıştır.

*The Life jackets are equipped with reflective Solas type 100 cm<sup>2</sup> tape strips, zip closure, hem tightening drawstring, a signalling whistle and with 100 newtons of buoyancy.*



### M02400 100N

#### YETİŞKİN CAN YELEĞİ / ADULT LIFE JACKET

Reflektörler Solasa uygun 100 cm<sup>2</sup> dir.

41 kg ve üzeri kullanıcılar içindir.

Minimum 100N kaldırma kuvveti sağlar.

*The Life jackets are equipped with reflective Solas type 100 cm<sup>2</sup> tape strips, a signalling whistle and with 100 newtons of buoyancy.*

	M02350	M02355	M02360	M02365
Beden / Size	S	M	L	XL
Yüzdürme / Buoyancy	70 N	80 N	100 N	100 N
Vücut Ağırlığı / Body Weight	40-60 kg	60-70 kg	70-90 kg	+ 90 kg

	M02300	M02310	M02320
Beden / Size	S	M	L
Yüzdürme / Buoyancy	40 N	40 N	50 N
Vücut Ağırlığı / Body Weight	15-30 kg	30-35 kg	35-40 kg



Patented



M02515 AUTOMATIC  
M02516 MANUAL



### M02401

#### CAN YELEĞİ

#### KORUMA VE TAŞIMA ÇANTASI

#### LIFE JACKET CARRY BAG

5 adet 100N saklamak için 35X65X36cm

7 adet 100N saklamak için 35X65X50cm

For 5 pieces 100N storage 35X65X36cm

For 7 pieces 100N storage 35X65X50cm



### M02404

#### CAN YELEĞİ

#### SAKLAMA

#### KUTUSU / LIFE JACKET

#### PROTECTION

#### AND STORAGE



(SOLAS)



## CAN YELEKLERİ / LIFE JACKETS

Martek Yetişkin Can yelekleri yüzmeyen ve bilmeyenler için tüm sularda ve zor hava koşullarında kullanılabilmesi için tasarlanmıştır. İkinci kemeri ile tutuculuğu takviye edilmiştir. Liman ve Kabotaj seferi yapan gemilerin yanı sıra, uluslararası sefer yapan yük ve yolcu gemilerinde de kullanılabilir. İçi kısmı kapalı hücre polietilen levhalardan oluşmaktadır. Yüksek görüş kabiliyetli oranj renkte kumaştan imal edilmiştir. Dümen işareti sertifikasına sahiptir. 140 kg'a kadar ağırlığı ve 1750 mm'ye kadar karın çevresi olan kişilerce kullanılabilecek şekilde tasarlanmıştır. 1 Temmuz 2010 itibariyle uygulanması zorunlu olan MSC düzenlemeleri 200(80) ekiyle 81(70) ve 207(81) ekiyle 48(66)'ya uygundur. Martek can yeleklerinin M02515 ya da M02516 Martek can yelek ışıkları ile kullanılmasını tavsiye ederiz.

*Martek Life jackets are designed for swimmers and non-swimmers to use in rough weather waters. Tightness is supported with additional belt. Can be used onboard not only vessels for inland waters but also on vessel with unlimited voyages. Buoyancy is provided by closed cell polyethylene foams. High visible orange colour fabric. SOLAS graded(Wheelmark) according to the directive of 96/98/EC. Designed to fit persons weighting up to 140 kgs and with chest grip of up to 1750mm. Fully in accordance with IMO MSC 81(70) as ammended with MSC 200(80) and MSC 48(66) as ammended with 207(81) Martek M02600 life jacket advised to be used with M02515 or M02516 Martek life jacket lights.*



**M02600**

**YETİŞKİN CAN YELEĞİ / ADULT LIFE JACKET**  
43 ila 140 kg arası yetişkinler içindir.  
*Adults from 43 kgs up to 140 kgs*



**M02550**

**ÇOCUK CAN YELEĞİ / CHILD LIFE JACKET**  
15 ila 43 kg arası çocuklar içindir.  
*Children from 15 kgs up to 43 kgs*



**M02540**

**BEBEK CAN YELEĞİ / INFANT LIFE JACKET**  
15 kg'a kadar olan bebekler içindir.  
*Infants up to 15 kgs*



## 50N YÜZDÜRME YARDIMCILARI / BUOYANCY AIDS

Yüzme bilenler tarafından korunaklı sularda kullanılmalıdır. Yüksek görünüm özellikli renkte kumaşlardan üretilmektedir.

Bir can yeleği değildir. 89/686/EEC direktifine ve ISO 12402-5'e göre CE onaylıdır.

Yüzdürme yardımcıları sadece boğulma riskini azaltır kurtarmayı garanti etmez.

*Buoynancy aids should be use in inshore and coastal waters. Produced with high visible fabrics. Not classified as lifejackets.*

*Buoynancy is provided by closed cell polyethylene foams. CE approved according to ISO 12402-5.*

*Buoynancy aids help to reduce drowning risk but do not guarantee to be rescued.*



### 50N KLASİK YÜZDÜRME YARDIMCISI ADULT CLASSIC BUOYANCY AIDS (PLASTIC CLIP)

Su sporları ve aktivitelerinde rahat kullanım sunar. Üzerindeki dört adet kayış tokalar ile sabitlenir.

*For water sports and activities.*

*4 pieces of straps are fastened with buckles.*

	M02710	M02712	M02714	M02716	M02718
Beden / Size	S	M	L	XL	XXL
Yüzdürme / Buoyancy	40 N	40 N	45 N	50 N	50 N
Vücut Ağırlığı / Body Weight	40-45 kg	50-60 kg	60-70 kg	70 +kg	70 ++kg



### 50N KLASİK YÜZDÜRME YARDIMCISI-FERMUARLI CLASSIC BUOYANCY AIDS (ZIP+PLASTIC CLIP)

Su sporları ve aktivitelerinde rahat kullanım sunar. Üzerindeki kayış, toka ile sabitlenmekte ve fermuar ile kullanıcıya maksimum uyum sağlamaktadır.

*Special design for watersport activities.*

*Strap is fastened with buckle. Zip at the front.*

	M12710	M12712	M12714	M12716	M12718
Beden / Size	S	M	L	XL	XXL
Yüzdürme / Buoyancy	40 N	40 N	45 N	50 N	50 N
Vücut Ağırlığı / Body Weight	40-50 kg	50-60 kg	60-70 kg	70 +kg	70 ++kg



### 50N SPORCU YÜZDÜRME YARDIMCISI 50N SPORTSMAN BUOYANCY AIDS

Küçük tekne kullanıcıları, sörfçüler, kanocular, optimist ve lazer kullanıcıları için idealdir.

Ön tarafındaki malzeme koymaya yarayan cep kumaş ve beli sıkıya yarayan etek ucu ipleri sayesinde kullanıcıya hem güvenlik hem de performans yönünden en iyisini sunmaktadır. Ayrıca omuzlarda ayarlanabilir toka kayış düzenine sahiptir.

*Designed for dinghy, canoe, windsurf, optimist and laser.*

*Mesh front pocket. Adjustable shoulder, strap is fastened with buckle*

	M22708	M22710	M22712	M22714	M22716
Beden / Size	XS	S	M	L	XL
Yüzdürme / Buoyancy	35 N	40 N	40 N	45 N	50 N
Vücut Ağırlığı / Body Weight	30-40 kg	40-50 kg	50-60 kg	60-70 kg	70+ kg



### 50N KANO/KAYAK YÜZDÜRME YARDIMCISI 50N CANOE/KAYAK BUOYANCY AIDS

Kano, kayak, küçük tekne kullanıcıları için idealdir. Bel, omuz ve yanlarda ayarlanabilir toka kayış düzenine sahiptir.

*Designed for dinghy sailing, canoe, ski. Adjustable shoulder, side straps, waist band and bottom tie.*

	M42710	M42712	M42714	M42716	M42718
Beden / Size	S	M	L	XL	XXL
Yüzdürme / Buoyancy	40 N	40 N	45 N	50 N	50 N
Vücut Ağırlığı / Body Weight	40-50 kg	50-60 kg	60-70 kg	70+ kg	70++ kg

## NEOPREN DARBE YELEĞİ / *IMPACT VEST*



	M52710	M52712	M52714	M52716
Beden / Size	S	M	L	XL

UYARI: Bu yelek bir can yeleği veya yüzdürme yardımcısı değildir. Bu yelek giyen kişiyi boğulma veya yaralanmalardan korumayacaktır. Bu yelek bir emniyet giysisi değildir. Onay kuruluşlardan herhangi bir sertifikası yoktur. Kullanıcı yeleği kullanırken yaralanma veya ölüm gibi oluşabilecek tüm riskleri kabul eder. Bu yelek yüzmeyen kişiler tarafından giyilemez. Bu yeleğin yüzdürme yeterliliği bilinçli veya bilinçsiz kullanıcılar için uygun değildir. Baygın durumdaki kullanıcıyı yüz üstü çevirmez.  
**WARNING: This Garment is not a life jacket or flotation device.**  
*This garment will not protect the wearer from injury or drowning. This garment is not a safety device and is not approved by notified bodies. The user assumes all risks of injury or death while using it. This garment should not be worn by anyone who cannot swim. The buoyancy factor and its distribution in the garment are not sufficient to float a conscious or unconscious person. Injury or drowning could occur while wearing this garment. It does not turn unconscious user's face up.*

- ÖZEL GÜÇLENDİRİLMİŞ DİKİŞLER  
*SPECIAL REINFORCED STITCHING*
- FERMUARLI YAPI  
*FRONT ZIP*
- DARBE EMİCİ FOAM  
*IMPACT REDUCER FOAM*
- MAKSİMUM HAREKETLİLİK İÇİN HAFİF TASARIM  
*LIGHTWEIGHT DESIGN FOR MAXIMUM MOBILITY*
- KITE SÖRFTTE KULLANIM İÇİN İDEAL  
*BEST FOR WEARING DURING KITE SURFING*

## YÜZDÜRÜCÜ CEKET / *FLOTATION JACKET*



Teknik giysi / *Technical wear*

	M02450	M02451	M02452	M02453	M02454
Beden / Size	S	M	L	XL	XXL

Kumaş: %100 Naylon  
 Astar: %100 Polyester  
 Yüzdürücü: Kapalı Hücre Polietilen Levha  
 \*Su tahliyesi için etek ucunda bulunan file kumaş  
 \*Kumaş gibi fermuarda rüzgar ve suyu dışarıda tutar

*Outer shell: %100 Nylon  
 Lining: %100 Polyester  
 Floating material: Closed Cell Polyethylene Sheet  
 Mesh drainage to prevent water log at the inner lower ends of jacket  
 full front zipper with storm flap to keep wind and water out*



## YÜZDÜRÜCÜ YELEK / *FLOTATION VEST*



	M02440	M02441	M02442	M02443	M02444	M02445
Beden / Size	S	M	L	XL	XXL	XXXL

## DENİZCİ CEKETİ / *SAILOR JACKET*

Kumaş: %100 Polyester • Astar: %100 Polyester  
 \*Dış yüzünde 2 ve iç yüzünde 1 adet olmak üzere toplam 3 adet cep  
 \*Fermuarda rüzgar ve suyu dışarıda tutmak için koruma kapağı  
 \*Cırt bant ile ayarlanabilir kapşon  
 \*Daraltmaya yarayan etek ve kapşon kısmında lastikli kordon  
 \*Bileklerde ayarlanabilen cırt bant

*Outer shell: %100 Polyester • Lining: % 100 Polyester  
 \*Storages placed 2 outside 1 inside 3 in total  
 \*Full front zipper with storm flap to keep wind and water out  
 \*Adjustable hood with velcro  
 \*Interior lastic belts at hood and at the lower end of jacket  
 \*Adjustable velcro wrist closure*



	M02465	M02466	M02467	M02468	M02469	M02470
Beden / Size	S	M	L	XL	XXL	XXXL

## M02900

### TULUM TİPİ YÜZDÜRME VE ISI KORUYUCU ELBİSE *FLOATING AND HEAT PROTECTIVE TECHNICAL WEAR*

Görünürlülüğü artırmak için tulum dış kumaşı Oranj-Kırmızı renk bandındadır.  
 Dizlerde ve oturma yerlerindeki aşınmayı önlemek için takviye kumaş.  
 Üzerinde retro reflektif-yansıtıcı bantlar. Diz üstünde, bacaklarda ve Bel kısmında toka ve kemer.  
 Tulum önünde çift taraflı elcik ve kemik fermuar. Her cep altında suyun kolay dreyn olması için çıkış delikleri. Yüzdürme ve ısı koruma amaçlı kapalı hücre polietilen köpük.  
 Yüzdürme min.50N



- *Outer shell: synthetic orange-red fabric*
- *Reinforced fabric to prevent abrasion on knees and seat.*
- *Retro reflective tapes*
- *Buckle and belt on legs above knee*
- *Buckle and belt at waist*
- *Full front zipper*
- *Drain holes for easy drainage of water inside each pocket*
- *Floating material, Closed cell Polyethylene sheet*
- *Buoyancy min. 50N.*

## CAN SİMİDLERİ VE NAL SİMİDLERİ / LIFE BUOYS AND HORSESHOE LIFE BUOYS

Can Simidlerinin dışı polietilen malzeme, iç kısmı ise poliüretan ile kaplıdır. Can simidinin etrafı polietilen yüzdürücü halat ile çevrilmiştir. Üzerlerinde 400 cm<sup>2</sup> solas' a uygun reflektif bant mevcuttur. Nal simidlerinin ise iç kısmı polietilen levha, dış yüzeyi ise kumaş ile kaplıdır. Yanlarında polietilen yüzdürücü halat mevcuttur.

*LIFE BUOYS: Colour-UV resistance orange, raw material-Polyethylene inside-Polyurethane, surrounding rope - 400 cm<sup>2</sup> solas graded retro-reflective tape.*

*HORSESHOE LIFE BUOYS: Colour-orange-yellow-white, inside-polyethylene foam, outside-fabric, surrounding rope, plastic clips for fastening.*



**M02700** (2.5 kg)

**M02800** (4 kg)

İç Çap:42cm • Dış Çap: 72cm

Inner Diameter: 42cm Outer Diameter: 72cm



**M01100** (2.5kg)

İç Çap:41cm • Dış Çap: 62cm

Inner Diameter: 41cm Outer Diameter: 62cm



**M01800**

**NAL SİMİDİ**

**HORSESHOE LIFE BUOY**

SOLAS Kurallarına Göre: iç çap min.40 cm ve dış çap max.80 cm olmalıdır.

*SOLAS Regulations For Lifebuoys:*

*Inner diameter should not be less than 400 mm Outer diameter should not be more than 800 mm*



**BRAKETLER / BRACKETS**

**M01830 CAN SİMİDİ / LIFE BUOY**

**M01820 NAL SİMİDİ / HORSESHOE LIFE BUOY**

Teknede Can ve Nal simidini sabit olarak konumlandırmak için kullanılır. Üzerinde bulunan sabitleme delikleri ile gemide istenilen yerlere monte edilebilir. Klipsleri sayesinde ışıklı şamandıra montajı kolaydır.

*It is used to fix the life buoy. Easy assembly due to the holes on its surface. Clips for life buoy light fixation.*

80mm



215mm

**M01810 IŞIKLI ŞAMANDIRA**  
**FLOATING LIFE BUOY LIGHT**

Işıklı şamandıra tehlike yok iken baş aşağı olarak braketine takılı konumda durmalıdır. Herhangi bir tehlike anında denize atıldığında denizin üzerinde düz konumda kalır ve beyaz ışık verir.

Led teknolojisine sahiptir. 3 adet AA kalem pil ile çalışır.

*Usage: flashing light for life buoys and horseshoe life buoys Raw material: plastic colour of light: white LED-type flashlight operates with AA battery(3pieces).*



147mm

26mm

**KURTARMA IŞIKLARI / RESCUE LIGHTS**

**M02510 FLAŞLI / FLASHED**

**M02511 FLAŞSIZ / NOT FLASHED**

**M02505 FOTOSELLİ IŞIK / PHOTOCCELL LIGHT**

2 adet AA Alkalın veya Lityum pil ile çalışır. Ağırlık 90 gr.

*Operated with 2 pieces AA alkaline or lithium battery. Weight 90 gr.*

**Patented**

# KURTARMA APARATLARI / RESCUE EQUIPMENTS

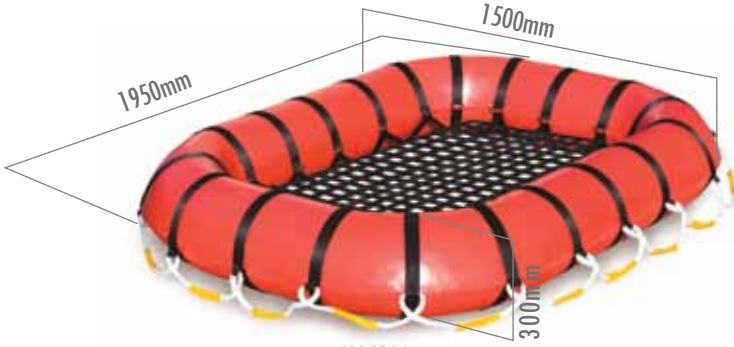

M04120

## KATI YAPILI CAN SALI / RIGID TYPE LIFE RAFT

Günlük gezi tekneleri, şehir hatları vapurları gibi yelkenli veya motorlu teknelerde katı yapılı can salı olarak kullanılır. Oranji renktedir. İç kısmı poliüretan, dış kısmı ise polietilen malzemeden imal edilmiştir. Ağırlığı 38 kg. Yüzdürmesi 2900N dur. 20 kişiliktir. For 20 people Usage: For use on sail or motor boats. Colour: orange / Inside: Polyurethane Raw material: Polyethylene / Weight: 38kg. Buoyancy: 2900N

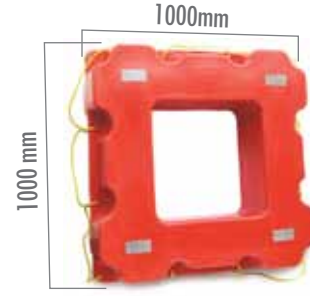

M04100

## KATI YAPILI CAN SALI / RIGID TYPE LIFE RAFT

Günlük gezi tekneleri, şehir hatları vapurları gibi yelkenli veya motorlu teknelerde katı yapılı can salı olarak kullanılır. Oranji renkte, iç kısmı poliüretan, dış kısmı ise polietilen malzemeden imal edilmiştir. Polietilen halat ve Solas'a uygun reflektör bantları vardır. Ağırlığı 20 kg. Yüzdürmesi 1800 N.dur. 12 kişiliktir. For 12 people. Solas type retro-reflective tapes on its surface. Usage: For use on sail or motor boats. Colour: orange / Inside: Polyurethane Raw material: Polyethylene Dimensions: 100x100x30cm. Weight: 20kg. / Buoyancy: 1800N



M04350

## YÜZER HALAT / FLOATING ROPE

Can simidi standardında istenen yüzmeye özelliğine sahip 30 mt. (Ø 8 mm) halattır 30 meters (Ø 8 mm) of floating rope for life buoy.



M04300

## HALAT ATAR / RESCUE THROW BAG

İçinde 30 mt halat bulunan bu çanta birkaç saniye içinde kolaylıkla mağdura atılabilmesi için dizayn edilmiştir. Throw Bags can be opened and thrown within seconds. Designed for easy throwing and accuracy. 30mt line Weight:950 gr



M04210

## HAVUZLAR İÇİN KURTARMA APARATI / RESCUE APPARATUS FOR SWIMMING POOLS



M04200

## KURTARMA APARATI / RESCUE APPARATUS

PVC kumaştan imal edilmiştir. İçerisinde 40m. yüzer halat ve beli tamamen kavrayan içi polietilen köpük levha ile donatılmıştır. Kemerli mevcuttur. Usage: For rescue Colour: orange, yellow Raw material: PVC fabric Inside the bag: 40 meters of rope with polyethylene foam filled surrounding belt.



M04220

## KURTARMA KEMERİ / RESCUE TUBE

Ayarlanabilen tokalı kemeri vardır, içi polietilen levhadan oluşmaktadır. Filled with PE sheets.



M04230

## CAN KURTARMA TOPU / LIFESAVING BALL

Ø:350 mm x 260 mm Halat Uzunluğu/ Rope Length : 30 mt



M42706

## SIRTLI YÜZEN MİNDER / DOUBLE CUSHION

İç i polietilen levha, dış yüzeyi PVC kumaş ile kaplıdır.

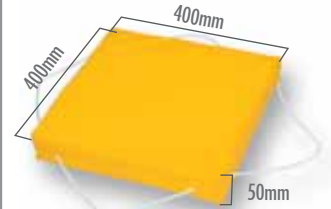

M42707

## TEKLİ YÜZEN MİNDER / SINGLE CUSHION

Inside : polyethylene foam Outside : PVC Fabric Surrounding Rope

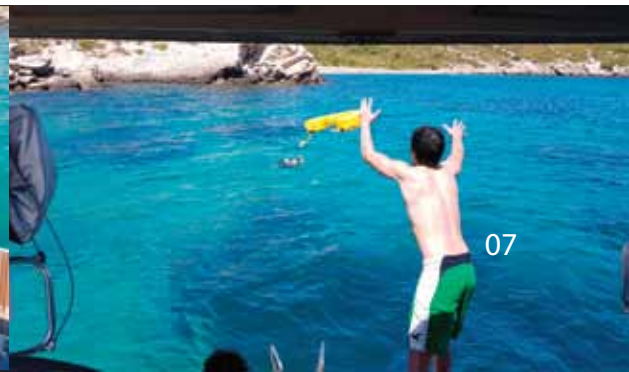

# BALIK ÇİFTLİĞİ ÇÖZÜMLERİ / FISH FARM SOLUTIONS



## KAFES BRACKETLERİ / CAGE BRACKETS

Polietilen malzemeden üretilmektedir. Polietilen boruların dış çaplarına göre dizayn edilmiştir. Ürünlerimizin içeriğinde gıda tüzüğüne uygun orjinal hammadde, antioksidant ve farklı kimyasal özelliklere sahip siyah pigmentler kullanılmaktadır. Antioksidant: Atmosferik oksitlenmeyi önler, ürünün ömrünü uzatır, dayanıklılık ve darbe direncini artırır. Siyah Pigment: UV direncini yükseltir. *Brackets are made of polyethylene and designed to fit the exterior dimensions of the pipes. Our products contain original raw materials conform to alimentary products regulations, antioxidants and pigments of different chemical features. Antioxidant: Prevents atmospheric oxidation, prolongs product life, and increases durability and impact resistance. Black Pigment: Increases UV resistance*



- M03620: Ø200
- M03625: Ø225
- M03650: Ø250
- M03680: Ø280
- M03615: Ø315

**2 BORULU KAFES BRACKETLERİ**  
**DOUBLE PIPE CAGE BRACKETS**

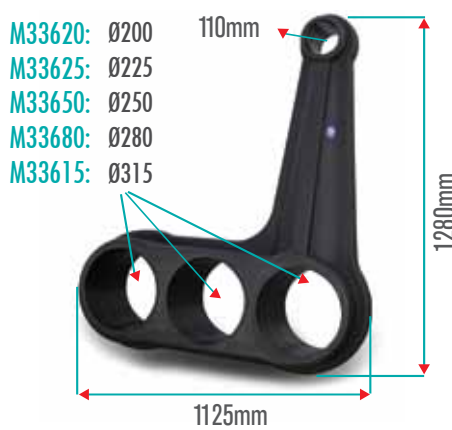

- M33620: Ø200
- M33625: Ø225
- M33650: Ø250
- M33680: Ø280
- M33615: Ø315

**3 BORULU KAFES BRACKETLERİ**  
**TRIPLE PIPE CAGE BRACKETS**



- M03655: Ø355
- M03640: Ø400
- M03645: Ø450
- M03600: Ø500

**2 BORULU KAFES BRACKETLERİ**  
**DOUBLE PIPE CAGE BRACKETS**

Ürün kodları kullanılacak boru çaplarına göre değişmektedir. *Product codes vary depending on the pipe diameter to be used*

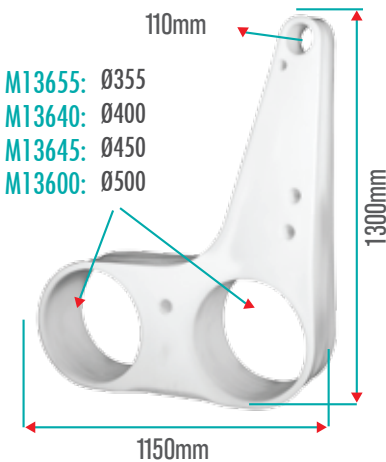

- M13655: Ø355
- M13640: Ø400
- M13645: Ø450
- M13600: Ø500

**FOSFORLU BRACKET**  
**PHOTOLUMINESCENT BRACKET**

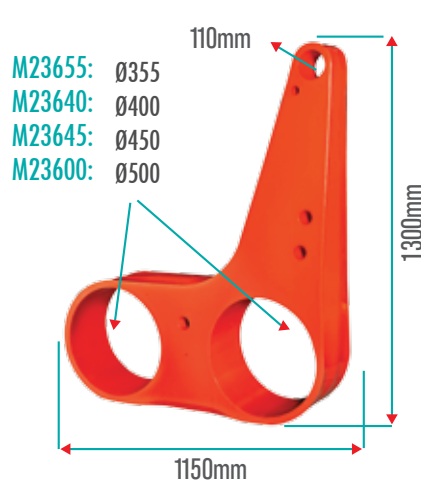

- M23655: Ø355
- M23640: Ø400
- M23645: Ø450
- M23600: Ø500

**ORANJ BRACKET / ORANGE BRACKET**



Siyah bracketlerle kurduğunuz sistemde herhangi bir kazaya karşı kafesinizin görünürlüğünü arttırmak için, Gündüz; En kolay görünen renk sarı-kırmızı bandında olduğundan oranj ve Gece; fosfor rengi (gündüz aldığı ışığı gece yansıtan) kullanmanız önerilir.

08 *In order to prevent accidents and increase your farms visibility during the day, the use of orange color is suggested because being in the yellow-red bandwidth makes it the easiest seen color, and at night the use of photoluminescent (reflects the light it absorbs during the day) is suggested for visibility.*



## KAFES AKSESUARLARI / CAGE ACCESSORIES

Kuş ağı kuleleri, braket stoperi, ağ numaratorü, tonoz, çelik kollektör, firdöndü, PE tekne, aş pontonu, hasat tankları, kuş ağı kuleleri, solar fenerler, şamandıralar ve benzeri balık çiftliğiniz için gerekli aksesuarları firmamızdan temin edebilirsiniz.

*Accessories such as Net towers Bracket Stopper, fish cage net maker, ballast, stainless steel collector, swivel, PE boat, vaccination pontoon, harvest tanks, net towers, solar lanterns, buoys etc can supplied by our company.*



### BRAKET STOPERLERİ / BRACKET STOPPER

Ürün kodları boru çaplarına göre değişmektedir.

*Product codes vary depending on the pipe diameter to be used*

**M22250:** Ø225 & Ø250mm boru için / For pipe

**M28315:** Ø280 & Ø500mm boru için / For pipe



### M22251

**AĞ NUMARATÖRÜ**  
**FISH CAGE NET MAKER**



**KOLLEKTÖR, KİLİT, DEMİR VE FIRDÖNDÜ**  
**COLLECTOR, SHACKLE, ANCHOR AND SWIVEL**

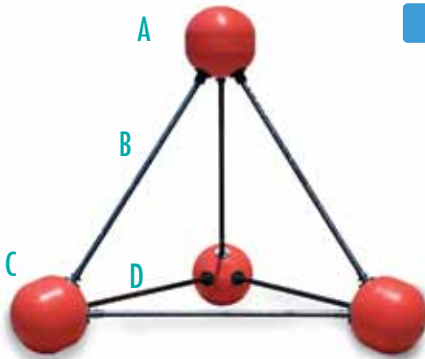

**KUŞ AĞI KULELERİ / NET TOWERS**

**Patented**

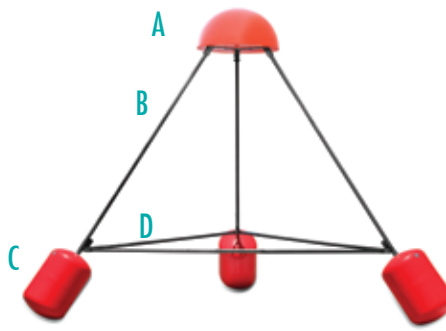

**KUŞ AĞI KULELERİ / NET TOWERS**

- A: PE Tepelik
- B: Dışı PE, içi sıcak daldırma galvaniz yükseklik borusu
- C: Taban şamandırası (İsteğe bağlı EPS, PU veya boş)
- D: Dışı PE, içi sıcak daldırma galvaniz taban borusu

- A: PE Top
- B: Outside PE, inside hot dip galvanized steel height pipe
- C: Bottom Buoy (filled with EPS, PU or empty)
- D: Outside PE, inside hot dip galvanized steel base pipe

Ürün kodları ürünlerin yükseklik ve taban çapına göre değişmektedir.  
*Product codes vary depending on the height of products and bottom diameter*

Yükseklik Taban Çapı / Height Base Diameter

<b>M13025:</b>	2,5m	3,80m
<b>M13030:</b>	3,0m	4,50m
<b>M13035:</b>	3,5m	5,15m
<b>M13040:</b>	4,0m	5,80m

Yükseklik Taban Çapı / Height Base Diameter

<b>M13015:</b>	1,5m	1,99m
<b>M13020:</b>	2,0m	2,60m



## MK4000 MODÜLER BALIK KAFESLERİ / MODULAR FISH FARMING CAGES

Kano şeklindeki içi isteğe bağlı eps veya poliüretan dolgulu modüler parçalardan oluşmaktadır. Modüler parçaları birleştirerek kare, dikdörtgen, altıgen, sekizgen balık kafesleri tek bir anahtarla başka hiçbir alete ihtiyaç duymadan ister su içinde istenirse karada monte edilir.

*The screens consist of eps or polyurethane injected (optional) canoe interior shaped parts. The modular parts can be mounted in square, rectangle, hexagon and octagon configurations. The installation requires a single wrench and no other tools at all. The screens can be mounted both on land and in water.*

Patented



### M03003 PE Yüzdürücü / Floater :

En / Width : 36 cm • Boy / Length : 337 cm

Yükseklik / Height : 37 cm

İç kısmı EPS veya Poliüretan dolu

Interior: EPS or Polyurethane injected

Single Module Dimensions :

Width: 45cm • Length: 400 cm

Height:Varies depending on material used.

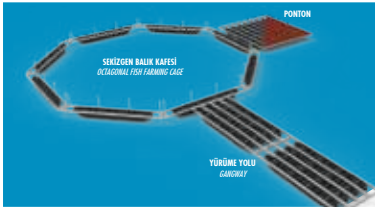

### KOLAY MONTE EDİLEBİLEN DAYANIKLI DEMONTE TASARIM

*EASY TO MOUNT,  
DURABLE, DEMOUNTABLE DESIGN*

Üründe kullanılan Neopren ara bağlantı parçaları sayesinde hem kolay montaj imkanı sunar; hem de deniz şartlarına yüksek dayanıklılık sağlar.

*The neoprene parts used as connectors allow both easy mounting and high durability for marine conditions.*



### ÜZERİNDE YÜRÜMEYE VE ÇALIŞMAYA ELVERİŞLİ SUITABLE TO WALK AND WORK ON IT

Modüler balık kafeslerinin tasarımı çalışanların üzerinde rahatça yürümesi ve çalışması için tasarlanmıştır. Bu sayede çalışanlar işlerini daha kolay ve hızlı bitirebilirler.

*The modular fish screen is designed to allow workers to easily walk and work on it. This way workers can finish their work easier and faster.*



### HIZLI VE KOLAY AĞ TOPLAMA FAST AND EASY NET COLLECTION



### İSTENİLEN ÖLÇÜLERDE BİRLEŞTİRMEYİ SAĞLAYAN MODÜLER TASARIM MODULAR DESIGN ALLOWING CONNECTIONS AT DESIRED DIMENSIONS



### TEK BİR ANAHTARLA MONTAJ İMKANI SINGLE WRENCH ASSEMBLY



KARE MONTAJ / SQUARE MOUNTING  
400 cm x 400 cm



DIKDÖRTGEN MONTAJ / RECTANGULAR MOUNTING  
800 cm x 400 cm



ALTIGEN MONTAJ / HEXAGONAL MOUNTING  
İç Çap / Inner diameter: 693cm



SEKİZGEN MONTAJ / OCTAGONAL MOUNTING  
İç Çap / Inner diameter: 965cm



ÇOKLU YÜZDÜRÜCÜLÜ  
ALTIGEN MONTAJ  
MULTIPLE FLOATER  
HEXAGONAL MOUNTING



ÇOKLU YÜZDÜRÜCÜLÜ  
SEKİZGEN MONTAJ  
MULTIPLE FLOATER  
OCTAGONAL MOUNTING



## MİDYE ÇİFTLİĞİ ÇÖZÜMLERİ / MUSSEL FARM SOLUTIONS

UV-korumalı orjinal polietilenden üretilmektedir. İstenirse içerisine EPS veya PU basılabilmektedir.  
*Raw Material: UV-stabilised polyethylene Optionally filled with EPS or PU*

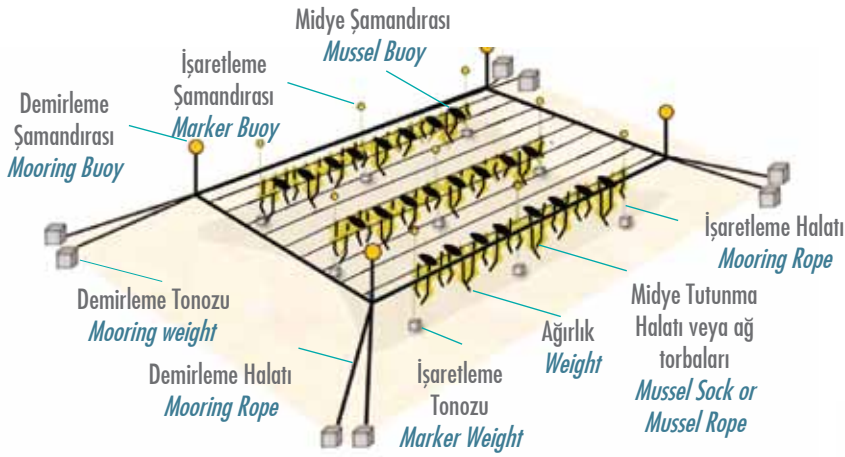

**MK4001**  
 MİDYE KAFESİ / MUSSEL FARMING CAGE

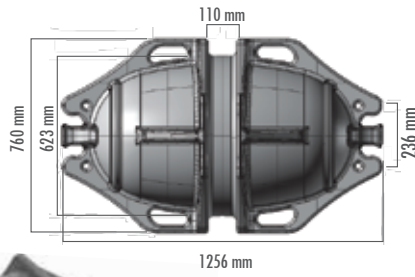

**M03341**  
 200 lt MİDYE ŞAMANDIRASI / MUSSEL BUOY  
 Yüzdürmesi / Buoyancy: 180 kg

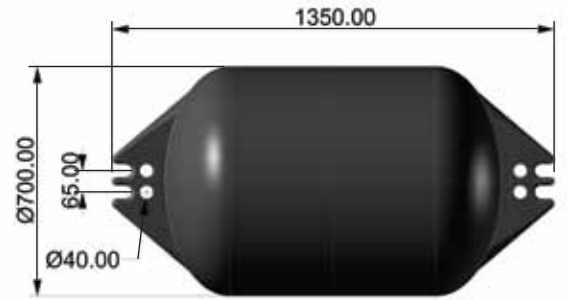

**M03342**  
 350 lt MİDYE ŞAMANDIRASI / MUSSEL BUOY  
 Yüzdürmesi / Buoyancy: 295 kg



**M04660 HASAT TANKI (660LT)**  
**HARVEST TANK (660 LT)**

Dış çift cidar monoblok polietilenden üretilmekte ve optimum izolasyon için cidarlar arası poliüretan ile doldurulmaktadır. Kolay temizlenebilen yüzeylere sahiptir. Özel tasarımı sayesinde palet gerektirmeden forklift ve transpalet bıçakları ile taşınabilir. Alt tabanlardaki yukarı bombe sayesinde dreyn işlemleri kolaylaşır. İki adet dreyn boşluğu mevcuttur.

*Raw Material: Polyethylene double hull filled with polyurethane for optimum isolation  
easy to clean Suitable for forklift handling Convex Bottom Design and two hole for easy drain*



**M04662 HASAT TANKI (1100LT)**  
**HARVEST TANK (1100 LT)**



**M04660**  
**ÖLÇÜLER / DIMENSIONS**

Dış Ölçüler / Outside dimensions :  
En / Width : 99.5 cm  
Boy / Length : 118 cm  
Yükseklik / Height : 81 cm  
İç Ölçüler / Inside dimensions :  
En / Width : 93 cm  
Boy / Length : 112 cm  
Yükseklik / Height : 65 cm  
Kapasite / Capacity : 660 Lt

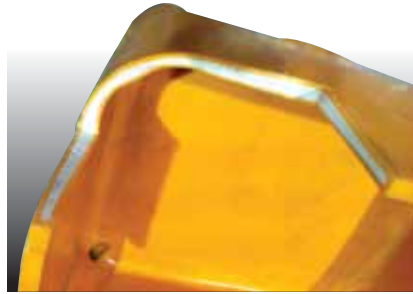

**İZOLASYON SAĞLAYAN POLİÜRETAN İÇ YAPI**  
**POLYURETHANE FILLED FOR ISOLATION**



**FORKLİFT VE TRANSPALET İLE**  
**TAŞIMAYA UYGUN TASARIM**  
**SUITABLE FOR FORKLIFT**  
**AND PALLET TRUCK HANDLING**



**M04662**  
**ÖLÇÜLER / DIMENSIONS**

Dış Ölçüler / Outside dimensions :  
En / Width : 115 cm  
Boy / Length : 145 cm  
Yükseklik / Height : 97 cm  
İç Ölçüler / Inside dimensions :  
En / Width : 97 cm  
Boy / Length : 127 cm  
Yükseklik / Height : 80 cm  
Kapasite / Capacity : 1100 Lt



### M04661 BUZ TANKI / ICE TRANSPORTATION TANK (660 LT)

Dışı çift cidar monoblok polietilenden üretilmekte ve optimum izolasyon için cidarlar arası poliüretan ile doldurulmaktadır. Kolay temizlenebilen yüzeylere sahiptir. Tekerlekli altyapısı herhangi bir taşıyıcı gerektirmeden çalışanlara tankı hareket ettirme imkanı sunar.

*Raw Material : Polyethylene double hull filled with polyurethane for optimum isolation easy to clean wheels allow for easy carrying and moving without using any equipment*



#### M04661

#### ÖLÇÜLER / DIMENSIONS

Dış Ölçüler / Outside dimensions :

En / Width : 99.5 cm

Boy / Length : 118 cm

Yükseklik / Height : 81 cm

İç Ölçüler / Inside dimensions :

En / Width : 93 cm

Boy / Length : 112 cm

Yükseklik / Height : 65 cm

Kapasite / Capacity : 660 Lt

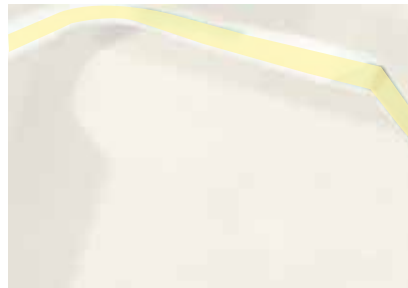

#### İZOLASYON SAĞLAYAN POLİÜRETAN İÇ YAPI POLYURETHANE FILLED FOR ISOLATION



#### KOLAY TAŞIMA İÇİN TEKERLEKLİ ALTYAPI WHEEL ATTACHED CONSTRUCTION FOR EASY CARRYING

Krom konstrüksiyon içinde 6 adet plastik tekerlekli alt yapısı sayesinde ağızına kadar buz doldurulsa bile güvenli taşıma sunmaktadır. Olduğu yerde dönebilen ve tek kişinin tank buz ile tamamen doldurulsa bile itebildiği bir hareketli yapıya sahiptir.

*With the help of 6 plastic wheels on stainless steel construction one worker can easily move tank even if it is full of ice. Tank can turn 360°.*



**M04658 İZOLASYONLU TANK (170LT) /THERMOBOX (170LT)**



**M04656 İZOLASYONLU TANK (80LT) /THERMOBOX (80LT)**

Dış çift cidar monoblok polietilenden üretilmekte ve optimum izolasyon için cidarlar arası poliüretan ile doldurulmaktadır. Kolay temizlenebilen yüzeylere sahiptir.  
*Raw Material : Polyethylene double dull dilled with polyurethane for optimum isolation easy to clean*



**M04658**

**ÖLÇÜLER / DIMENSION**

Dış Ölçüler / *Outside dimensions* :  
En / *Width* : 50 cm Boy / *Lenght* : 71 cm  
Yükseklik / *Height* : 76,5 cm  
İç Ölçüler / *Inside dimensions* :  
En / *Width* : 41,5 cm  
Boy / *Lenght* : 63 cm  
Yükseklik / *Height* : 64,5 cm  
Kapasite / *Capacity* : 170 Lt



**İZOLASYON SAĞLAYAN POLİÜRETAN İÇ YAPI  
POLYURETHANE FILLED FOR ISOLATION**



**İSTEĞE BAĞLI KABLO ÇIKIŞI  
OPTIONAL CABLE OUTPUT**

Dış ortamda akü koruma kutusu olarak kullanılması durumunda plastik dirsekle kablo çıkışı sağlanmaktadır.  
*If thermobox will be used as battery protection case, cable output can be provided by plastic elbow pipe.*



**M04656**

**ÖLÇÜLER / DIMENSIONS**

Dış Ölçüler / *Outside dimensions* :  
En / *Width* : 49 cm  
Boy / *Lenght* : 70,5 cm  
Yükseklik / *Height* : 42 cm  
İç Ölçüler / *Inside dimensions* :  
En / *Width* : 40 cm  
Boy / *Lenght* : 62,5 cm  
Yükseklik / *Height* : 32,5 cm  
Kapasite / *Capacity* : 80 Lt



**M06200 CANLI BALIK TAŞIMA TANKI**  
*FISH TRANSPORTATION TANK (2500 LT)*



**M06250 ANAÇ TANKI**  
*FISH TRANSPORTATION TANK (2500LT)*

Tek cidar monoblok polietilenden üretilmektedir. Kolay temizlenebilen yüzeylere sahiptir.  
Alt tabanlardaki yukarı bombe sayesinde dreyn işlemleri kolaylaşır.

*Raw Material : Polyethylene single hull convex bottom design for easy drain*



**M06200**  
**ÖLÇÜLER / DIMENSIONS**

Dış Ölçüler / *Outside dimensions* :  
Ø 140 cm. Yükseklik / *Height* : 160 cm  
Kapasite / *Capacity* : 2500 Lt



**M06250**  
**ÖLÇÜLER / DIMENSIONS**

Dış Ölçüler / *Outside dimensions* :  
Ø 184 cm. Yükseklik / *Height* : 108 cm  
Kapasite / *Capacity* : 2500 Lt

# MARTEK ŞAMANDIRALAR / *BUOYS*



**martek**<sup>®</sup>

## EPS-GENLEŞTİRİLMİŞ POLİSTREN KÖPÜK

### EPS- EXPENDED POLYSTYRENE FOAM

Genleştirilmiş Polistiren sert köpük strien monomerin polimerizasyonu ile petrolden elde edilen, köpük haldeki kapalı gözenekli tipik olarak beyaz renkli bir termoplastik malzemedir  
*EPS Expanded Polystyrene rigid foam is a material obtained from the polymerization of styrene monomer and petroleum, a thermoplastic foam of white color having closed pores.*



## PU-POLİÜRETAN / PU-POLYURETHANE

Polioller ile izosiyanatların ekzotermik reaksiyonları sonucu oluşurlar. Rijit (sert) köpüktür.  
*Polyurethanes form after the exothermic reaction of the polyols and isocyanates. Polyurethanes exists in a rigid foam form.*

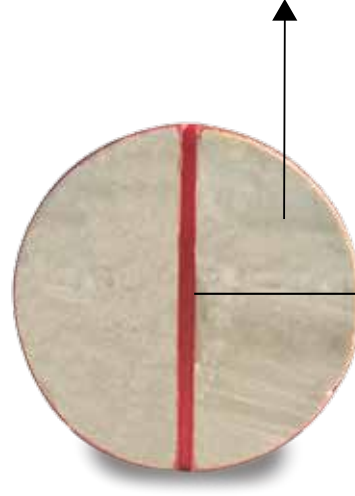

GÖVDE İLE  
BÜTÜNLEŞİK  
POLİETİLEN BORU  
BODY  
INTEGRATED  
PE PIPE

## ŞAMANDIRALAR / BUOYS

Polietilen malzemeden üretilmektedir. İsteğe bağlı iç kısmı EPS veya PU ile doldurulabilir. Bunun amacı herhangi bir şamandıraya çarpma veya vandalizm yapılması durumunda şamandıranın batmadan yüzeyde kalmasını sağlar. Ürünlerimizin içeriğinde orijinal hammadde, UV stabilizan ve antioksidant bulunmaktadır. Şamandıralarımızın üst noktasından alt noktasına kadar monoblok PE boru vardır, mil bu boru içersinden geçmektedir. Bu sayede şamandıranın içine su girmesi imkansızdır.

*Raw Material: UV-stabilised polyethylene with antioxidant. Optionally filled with EPS or PU filling application prevents water ingress in the unlikely event of damage( vandalism, accidents, etc) Body integrated Monoblock PE pipe inside the buoys (that cover metal shaft) create extra protection for water ingress.*

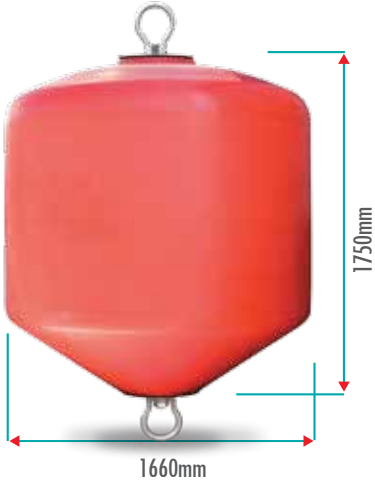

**M03280**  
2500 LT ŞAMANDIRA / BUOY  
Yüzdürmesi / Buoyancy: 2250 kg  
Ürün Ağırlığı / Weight: 166 kg

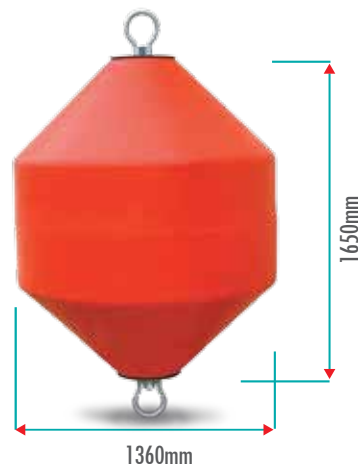

**M03290**  
1600 LT ŞAMANDIRA / BUOY  
Yüzdürmesi / Buoyancy: 1500 kg  
Ürün Ağırlığı / Weight: 110 kg

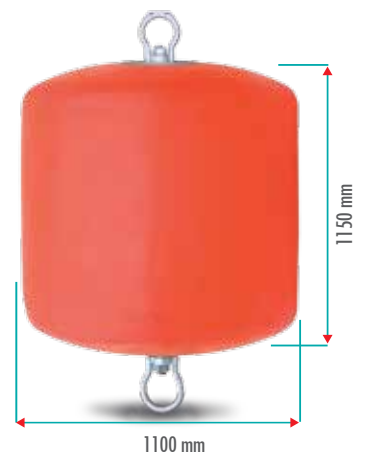

**M03300**  
1200 LT ŞAMANDIRA / BUOY  
Yüzdürmesi / Buoyancy: 1000 kg  
Ürün Ağırlığı / Weight: 90 kg

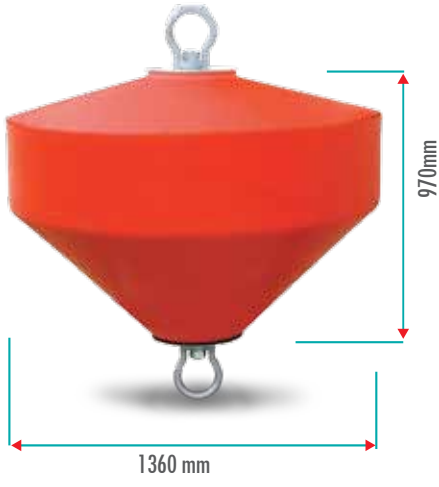

**M03305**  
900 LT ŞAMANDIRA / BUOY  
Yüzdürmesi / Buoyancy: 800 kg  
Ürün Ağırlığı / Weight: 65 kg

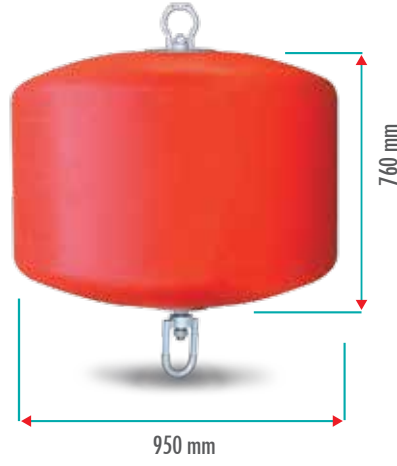

**M03310**  
600 LT ŞAMANDIRA / BUOY  
Yüzdürmesi / Buoyancy: 500 kg  
Ürün Ağırlığı / Weight: 60 kg



**M03303**  
500 LT ŞAMANDIRA / BUOY  
Yüzdürmesi / Buoyancy: 450 kg  
Ürün Ağırlığı / Weight: 38 kg



**M03259**  
450 LT ŞAMANDIRA / BUOY  
Yüzdürmesi / Buoyancy: 380 kg  
Ürün Ağırlığı / Weight: 50 kg



**M03251**  
390 LT ŞAMANDIRA / BUOY  
Ürün Ağırlığı / Weight: 114 kg

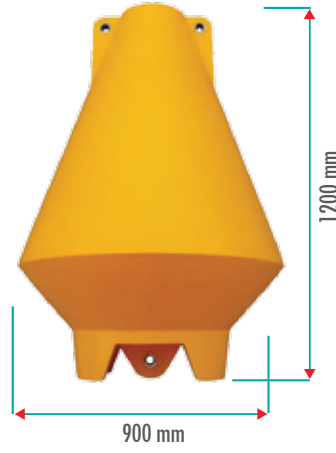

**M03326**  
350 LT ŞAMANDIRA / BUOY  
Yüzdürmesi / Buoyancy: 295 kg  
Ürün Ağırlığı / Weight: 80 kg

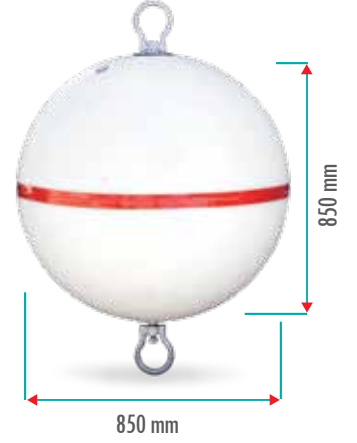

**M03325**  
320 LT ŞAMANDIRA / BUOY  
Yüzdürmesi / Buoyancy: 290 kg  
Ürün Ağırlığı / Weight: 30 kg

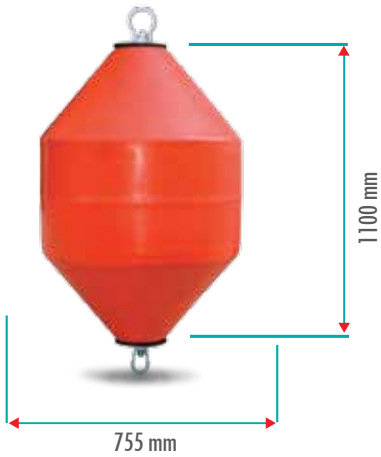

**M03330**  
300 LT ŞAMANDIRA / BUOY  
Yüzdürmesi / Buoyancy: 250 kg  
Ürün Ağırlığı / Weight: 28 kg



**M03345**  
200 LT ŞAMANDIRA / BUOY  
Yüzdürmesi / Buoyancy: 180 kg  
Ürün Ağırlığı / Weight: 17 kg



**M03340**  
200 LT ŞAMANDIRA / BUOY  
Yüzdürmesi / Buoyancy: 180 kg  
Ürün Ağırlığı / Weight: 22 kg

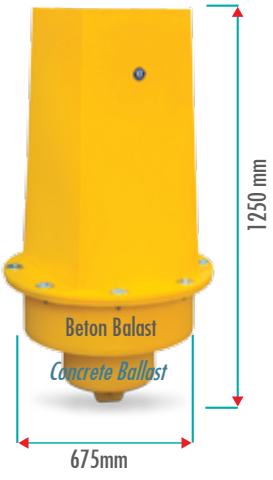

**M03255**  
180 LT ŞAMANDIRA / BUOY  
Ürün Ağırlığı / Weight: 18 kg

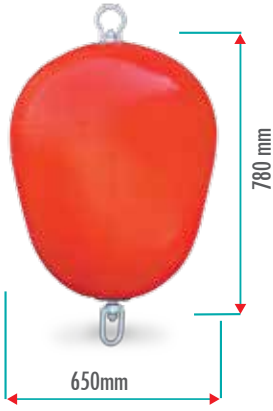

**M03091**  
170 LT ŞAMANDIRA / BUOY  
Yüzdürmesi / Buoyancy: 155 kg  
Ürün Ağırlığı / Weight: 18 kg



**M03355**  
100 LT ŞAMANDIRA / BUOY  
Yüzdürmesi / Buoyancy: 85 kg  
Ürün Ağırlığı / Weight: 10,5 kg

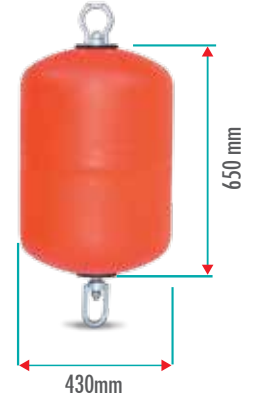

**M03350**  
100 LT ŞAMANDIRA / BUOY  
Yüzdürmesi / Buoyancy: 90 kg  
Ürün Ağırlığı / Weight: 11 kg

Not / Optional: İstenirse üzerine yazı yazılabilir fener ve tepelik monte edilebilir. *Lettering, numbering, signage, retro reflective tape, radar reflector, solar marine light, can or conical shapes*



**M03256**  
80 LT ŞAMANDIRA / BUOY  
Yüzdürmesi / Buoyancy: 70 kg



**M03552**  
70 LT ŞAMANDIRA / BUOY  
Yüzdürmesi / Buoyancy: 60 kg  
Ürün Ağırlığı / Weight: 8,5 kg  
Ortasında monoblok polietilen boru mevcuttur.  
İç boşluğu tamamen poliüretan ile kaplıdır.  
Dış yüzeyi polietilen malzemedir.  
Usage: Marking applications.  
Raw material: Polyethylene  
Inside: Polyurethane filled.



**M03254**  
53 kg  
ŞAMANDIRA / BUOY



**M03249**  
14 kg  
80 LT ŞAMANDIRA / BUOY



**M03250**  
30 kg  
80 LT ŞAMANDIRA / BUOY

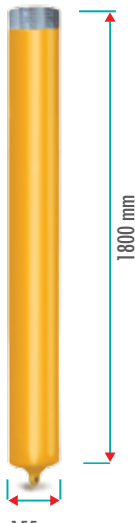

**M03253**  
30 LT ŞAMANDIRA / BUOY

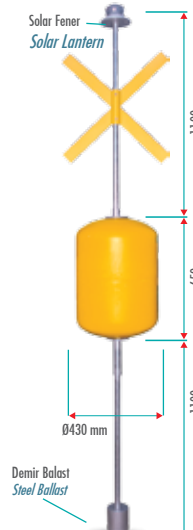

**M03260**  
26 kg  
ŞAMANDIRA / BUOY

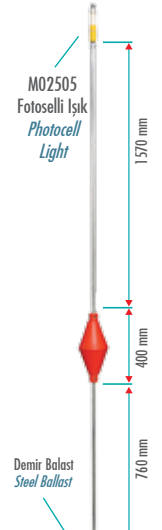

**M02505**  
Fotoselli Işık  
Photocell  
Light  
Demir Balast  
Steel Ballast  
**M03096**  
DAN BUOY



**M03360**

50 LT ŞAMANDIRA / BUOY

Yüzdürmesi / Buoyancy: 35 kg  
Ürün Ağırlığı / Weight: 4 kg



**M03361**

50 LT ŞAMANDIRA / BUOY

Yüzdürmesi / Buoyancy: 35 kg  
Ürün Ağırlığı / Weight: 4 kg

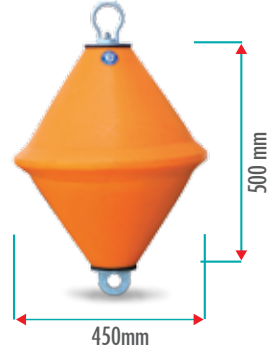

**M03205**

30 LT ŞAMANDIRA / BUOY

Yüzdürmesi / Buoyancy: 20 kg  
Ürün Ağırlığı / Weight: 4 kg

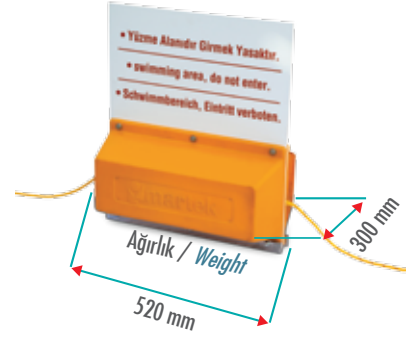

**M03252**

UYARI LEVHASI  
BARRIER FLOAT

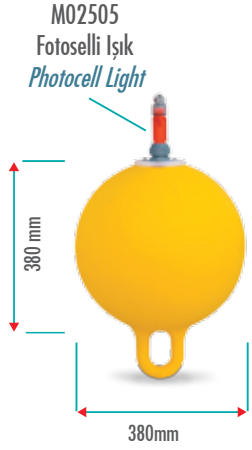

M02505  
Fotoselli Işık  
Photocell Light

**M03410** 26 LT

FENERLİ KÜRE ŞAMANDIRA  
GLOBE BUOY WITH LIGHT

Yüzdürmesi / Buoyancy: 25 kg  
Ürün Ağırlığı / Weight: 1,2 kg



**M03420** 26 LT

BAYRAKLI KÜRE ŞAMANDIRA  
GLOBE BUOY WITH FLAG

Yüzdürmesi / Buoyancy: 25 kg  
Ürün Ağırlığı / Weight: 1,2 kg



**M03430** 26 LT

BAYRAKLI ve FENERLİ KÜRE ŞAMANDIRA  
GLOBE BUOY WITH FLAG AND LIGHT

Yüzdürmesi / Buoyancy: 25 kg  
Ürün Ağırlığı / Weight: 1,2 kg

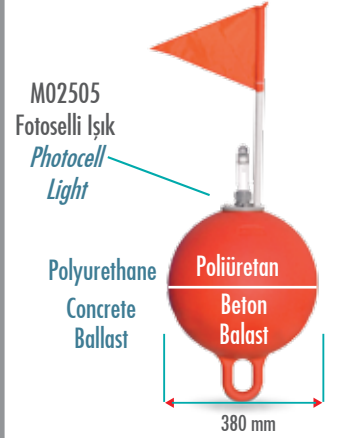

M02505  
Fotoselli Işık  
Photocell Light

Polyurethane  
Concrete  
Ballast

Poliüretan  
Beton  
Balast

**M03270**

26 LT BALIKÇI ŞAMANDIRASI  
FISHER BUOY

Yüzdürmesi / Buoyancy: 25 kg  
Ürün Ağırlığı / Weight: 3,5 kg



**M03400**

26 LT ŞAMANDIRA / BUOY

Yüzdürmesi / Buoyancy: 25 kg  
Ürün Ağırlığı / Weight: 1,2 kg



**M03240**

25 LT ŞAMANDIRA / BUOY

Yüzdürmesi / Buoyancy: 20 kg  
Ürün Ağırlığı / Weight: 4,7 kg

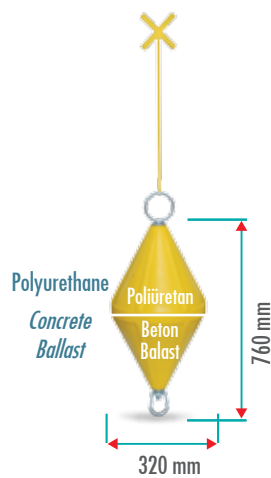

Polyurethane  
Concrete  
Ballast

Poliüretan  
Beton  
Balast

**M03201**

17 LT ŞAMANDIRA / BUOY

Yüzdürmesi / Buoyancy: 15 kg  
Ürün Ağırlığı / Weight: 4,7 kg

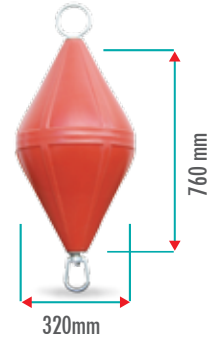

**M03200**

17 LT ŞAMANDIRA / BUOY

Yüzdürmesi / Buoyancy: 15 kg  
Ürün Ağırlığı / Weight: 2,7 kg



M03220

15 LT ŞAMANDIRA / BUOY

Yüzdürmesi / Buoyancy: 13 kg  
Ürün Ağırlığı / Weight: 1,2 kg

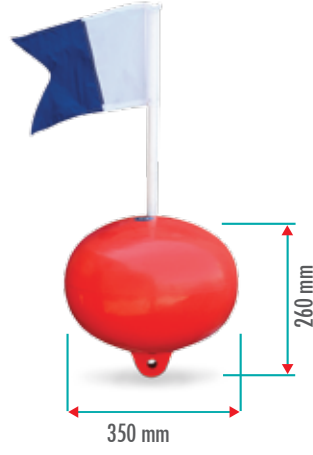

M03090

14 LT TAKİP ŞAMANDIRASI / APNEA BUOY

Yüzdürmesi / Buoyancy: 14 kg  
Ürün Ağırlığı / Weight: 1,5 kg

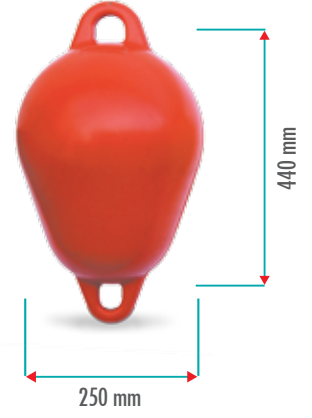

M03100

9 LT ARMUT ŞAMANDIRA / BUOY

Yüzdürmesi / Buoyancy: 8 kg  
Ürün Ağırlığı / Weight: 650 gr

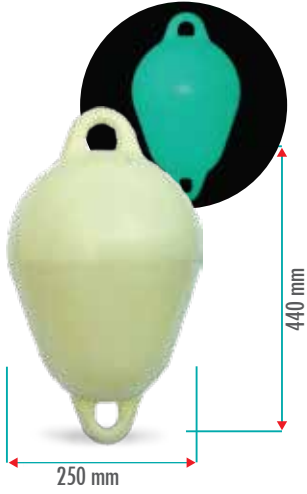

M03110

9 LT FOSFORLU ARMUT ŞAMANDIRA  
PHOTOLUMINESCENT PEAR-SHAPED BUOY

Yüzdürmesi / Buoyancy: 8 kg  
Ürün Ağırlığı / Weight: 650 gr

Not: Gündüz aldığı ışığı  
gece yansıtır. özelliğine sahiptir.  
At nights, it radiates the light  
which it absorbs during the day.

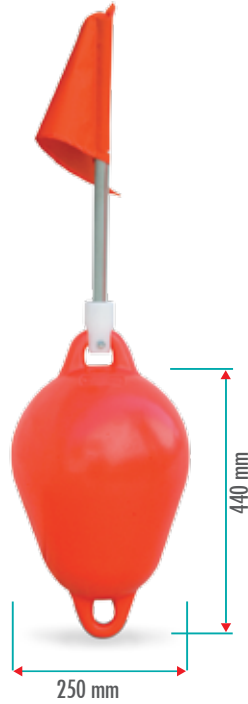

M03120

9 LT  
BAYRAKLI ARMUT ŞAMANDIRA  
PEAR-SHAPED BUOY WITH FLAG

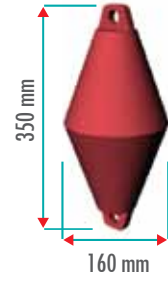

M03095 1,7 LT  
KONİK ŞAMANDIRA  
CONIC BUOY

Yüzdürmesi / Buoyancy: 1,5 kg  
Ürün Ağırlığı / Weight: 0,5 kg



M05604

400 x 900 mm DOLGU USTURMAÇA / FOAM FILLED FENDER

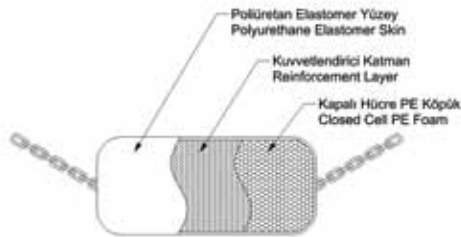

M05606

600 x 900 mm DOLGU USTURMAÇA / FOAM FILLED FENDER

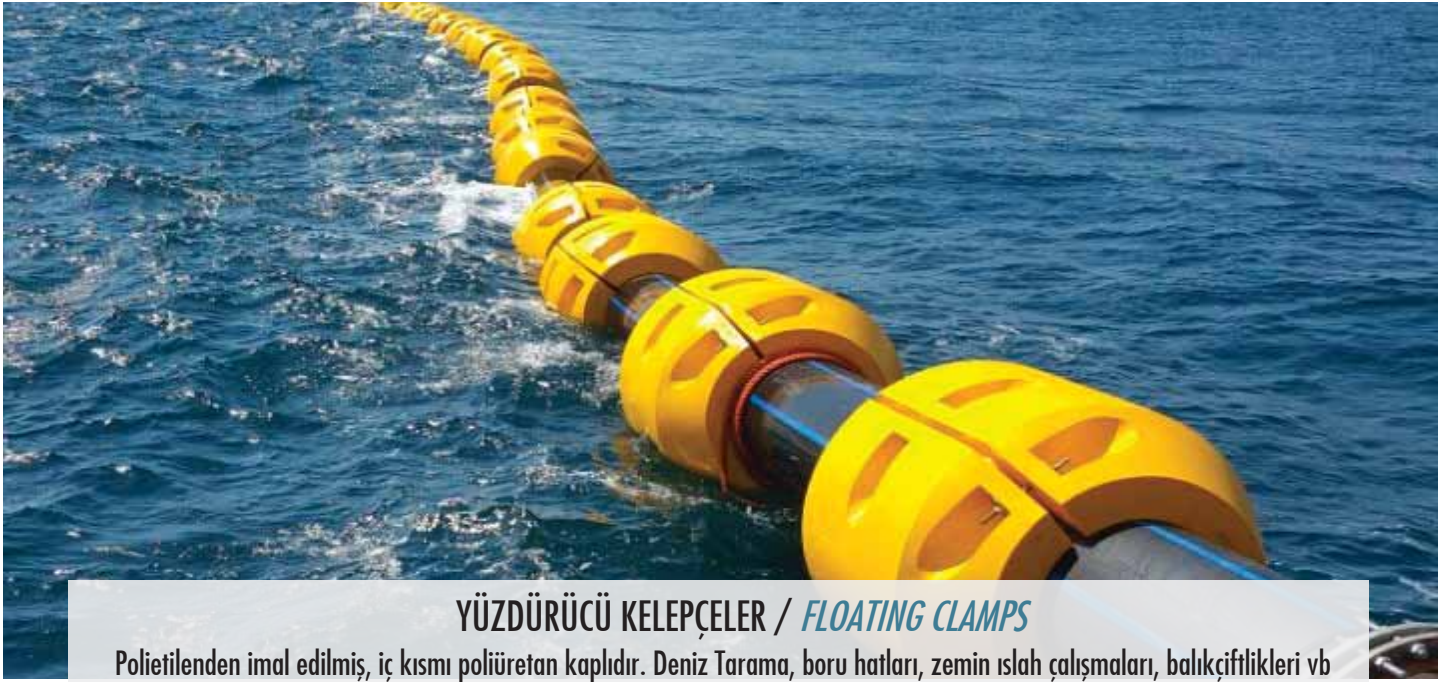

## YÜZDÜRÜCÜ KELEPÇELER / *FLOATING CLAMPS*

Polietilenden imal edilmiş, iç kısmı poliüretan kaplıdır. Deniz Tarama, boru hatları, zemin ıslah çalışmaları, balıkçiftlikleri vb boruların yüzdürülmesi uygulamalarında yaygın olarak kullanılmaktadır. İki parça halindedir ve sıcak daldırma galvaniz veya krom civata, somun, pul kullanılarak kolaylıkla birleştirilebilir.

*Produced of polyethylene and filled with polyurethane. Usage for pipeline laying operations ensuring positive buoyancy. Consists of 2 pieces being combined with hot dipped galvanized or stainless steel flanges, bolts and nuts.*

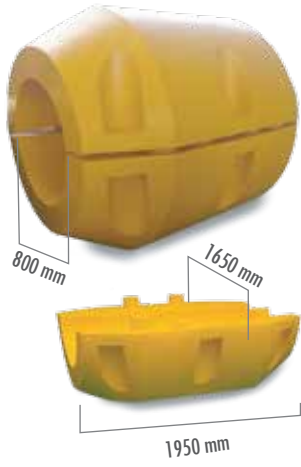

**M03580**  
2580 LT

Yüzdürmesi / *Buoyancy*: 2320 kg

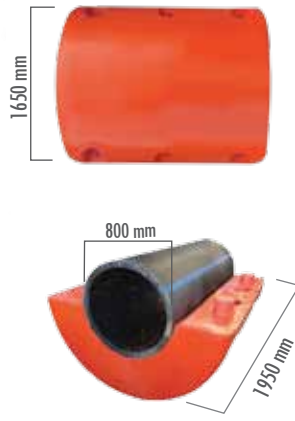

**M03581**  
3280 LT

Yüzdürmesi / *Buoyancy*: 2788 kg

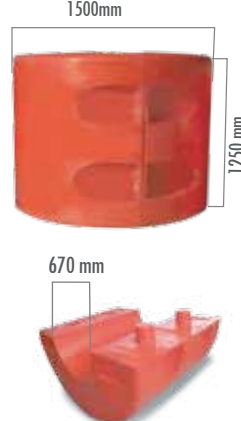

**M03567**  
1700 LT

Yüzdürmesi / *Buoyancy*: 1530 kg



**M03545**  
500 LT

Yüzdürmesi / *Buoyancy*: 450 kg



**M03550** 430 LT

Yüzdürmesi  
*Buoyancy*: 387 kg

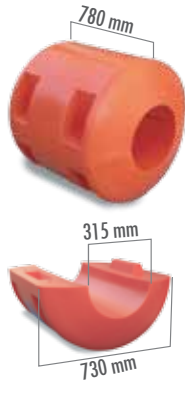

**M03532** 176 LT

Yüzdürmesi  
*Buoyancy*: 160 kg

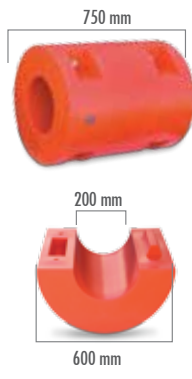

**M03527** 140 LT

Yüzdürmesi  
*Buoyancy*: 126 kg



**M03539** 70 LT

Yüzdürmesi  
*Buoyancy*: 62 kg



**M03528** 120 LT

Yüzdürmesi  
*Buoyancy*: 108 kg

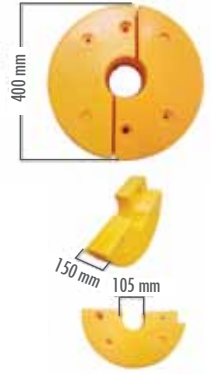

**M03510** 40 LT

Yüzdürmesi  
*Buoyancy*: 36 kg



## USTURMAÇALAR / FENDERS

Usturmanız fazla şişirilmemelidir. Standart usturmaça basıncı 0.15-0.20 bar aralığındadır. Tekne uzunluğu ne olursa olsun en az 6 adet usturmaça kullanılmalıdır. Bakım gerektirmez kirlendiğinde su ile temizleyin. Temizlik sırasında güçlü kimyasallar (aseton,tiner vb.) kullanmayınız.

*Do not over inflate. Fenders must be soft. Standard fender pressure is between 0.15 - 0.20 bar. Whatever your boat's length is, you should have at least 6 fenders.No maintenance, clean with water. When cleaning, do not use stronger chemicals such as acetone, thinner etc.*



**M05400**

30 m uzunluğa kadar olan tekneler içindir.  
*Up to 30 m.length ships.*



**M05300**

12 m uzunluğa kadar olan tekneler içindir.  
*Up to 12 m.length ships.*

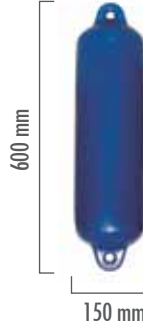

**M05200**

9 m uzunluğa kadar olan tekneler içindir.  
*Up to 9 m.length ships.*

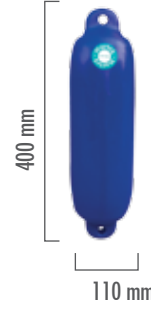

**M05110**

6 m uzunluğa kadar olan tekneler içindir.  
*Up to 6 m.length ships.*



**M05100**

6 m uzunluğa kadar olan tekneler içindir.  
*Up to 6 m.length ships.*

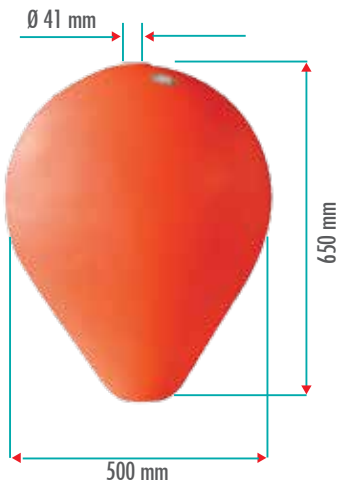

**M05603**

Ø500 mm x 650 mm . İç Çap: 41 mm.  
Esnek Merkez Borusu. PVC malzemeden yapılmıştır.  
Ø500 mm x 650 mm . Inner Diameter: 41 mm.  
*Flexible Central Tube. Raw material: PVC*



**M05602**

**DÜZ İSKELE USTURMAÇASI / FLAT BUMPER**  
Ø247 X 600 mm



**USTURMAÇA KILIFLARI / FENDER COVERS**

**M05400K** 350x900 mm  
**M05300K** 200x800 mm  
**M05200K** 150x600 mm  
**M05110K** 110x400 mm  
**M05100K** 110x350 mm



**M05600**

**KÖŞE / DÜZ İSKELE USTURMAÇASI**  
*Corner / Flat Bumper*



**M05601**



## BARIYER VE KULVAR ŞAMANDIRALARI / *LANE MARKERS & BARRIER FLOATS*

Kulvar şamandırası polietilen malzemeden üretilmektedir. İç yapısı istenildiği takdirde EPS veya PU köpük doldurulmaktadır. Kulvar tipleri yüzme veya su sporu aktivitelerinde tehlikeli alanların çevriliyerek işaretlenmesine yardımcı olur. Bariyer tipleri deniz güvenliğini sağlamak için korkuluk engel gibi kullanılabilir ayrıca denize müdahale işlemlerinde tecrit bölgesi oluşturur.

*Raw material: Polyethylene, Inside: Polyurethane or EPS foam. Lane Markers help to mark dangerous zones for swimming and water sports activations. Martek barrier floats can be linked together to restrict boating traffic and swimmers from entering specific danger areas such as spillways and dams.*



**M03526** 500 LT  
Ağırlık / *Weight*: 38 kg  
Yüzdürme / *Buoyancy*: 450 kg



**M03525** 320 LT  
Ağırlık / *Weight*: 30 kg  
Yüzdürme / *Buoyancy*: 290 kg

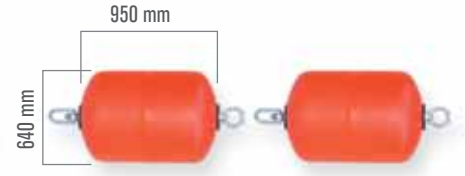

**M03524** 200 LT  
Ağırlık / *Weight*: 22 kg  
Yüzdürme / *Buoyancy*: 180 kg

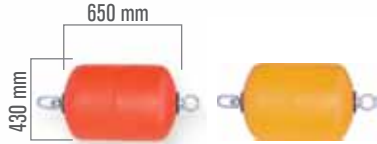

**M03523** 100 LT  
Ağırlık / *Weight*: 11 kg Yüzdürme / *Buoyancy*: 90 kg



**M03522** 390 LT  
Ağırlık / *Weight*: 25 kg Yüzdürme / *Buoyancy*: 350 kg



**M03521** 80 LT  
Ağırlık / *Weight*: 12 kg Yüzdürme / *Buoyancy*: 70 kg



**M03535** 77 LT  
Ağırlık / *Weight*: 5 kg  
Yüzdürme / *Buoyancy*: 70 kg

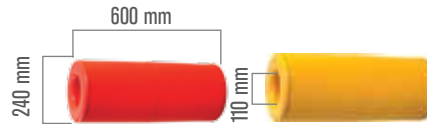

**M03519** 20 LT  
Ağırlık / *Weight*: 3,5 kg Yüzdürme / *Buoyancy*: 19 kg



**M03520** 22 LT  
Ağırlık / *Weight*: 1,8 kg  
Yüzdürme / *Buoyancy*: 20 kg

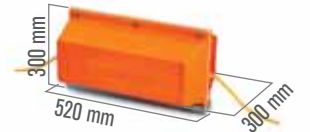

**M03518** 26 LT  
Ağırlık / *Weight*: 4,5 kg  
Yüzdürme / *Buoyancy*: 23 kg



**M03515** 9 LT  
Ağırlık / *Weight*: 0,9 kg  
Yüzdürme / *Buoyancy*: 8 kg



**M03540** 25 LT  
Ağırlık / *Weight*: 3,4 kg Yüzdürme / *Buoyancy*: 20 kg

# martek-NE / POLİETİLEN TEKNE

## MARTEK POLYETHYLENE BOATS

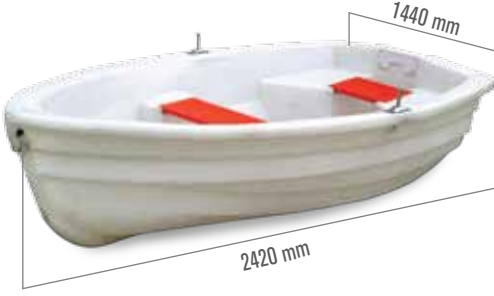

**NE242**

**POLİETİLEN TEKNE**  
**POLYETHYLENE BOAT**

Çift Cidarlı / *Double hull*  
Ağırlık / *Weight*: 50 kg

Kapasite / *Capacity*: 2 Kişi - *people* /160 kg.  
Tavsiye edilen güç / *Suggested Motor*:  
Max 2,5 HP



**NE237**

**POLİETİLEN TEKNE**  
**POLYETHYLENE BOAT**

Çift Cidarlı / *Double hull*  
Ağırlık / *Weight*: 50 kg

Kapasite / *Capacity*: 2 Kişi - *people*/160 kg.  
Tavsiye edilen güç / *Suggested Motor*:  
Max 2,5 HP

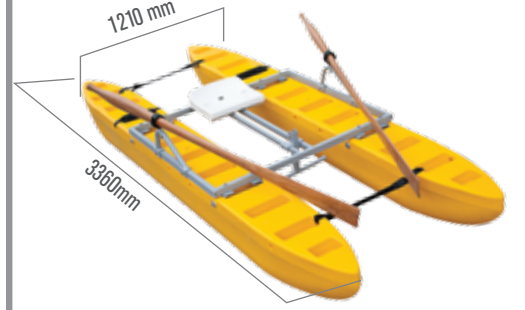

**NE336**

**KATAMARAN PE KÜREKLİ TEKNE**  
**CATAMARAN ROWING BOAT**

Ağırlık / *Weight*: 65 kg  
Kapasite / *Capacity*: 1 Kişi - *people* /100 kg.





### M77000 PALAMAR ŞAMANDIRA / MOORING BUOY (Ø 4000mm)

Liman içinde fazla saha işgal etmemeleri için gemilerin açıkta baştan ve kıçtan palamar vermek suretiyle bağlandıkları şamandıralardır. Yüzen polietilen kısım herhangi bir zarar görme durumunda kolaylıkla değiştirilebilecek modüler parçalardan oluşmaktadır. Suitable for port ,coastal and deep sea applications. Especially, These buoys are used for the open sea mooring of the biggest oil tankers. Modular floats used for this buoy are made from rotomolded polyethylene shells filled with polyurethane foam or EPS. The metallic structure is made in hot dip galvanized steel, and has the important duty to support the modular floats.

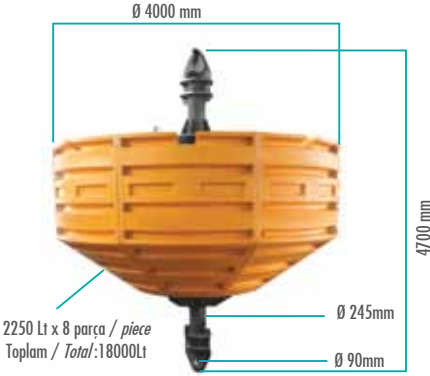

### M76100 PALAMAR ŞAMANDIRA / MOORING BUOY(Ø 3000mm)



### M75600 PALAMAR ŞAMANDIRA / MOORING BUOY(Ø 2500mm)

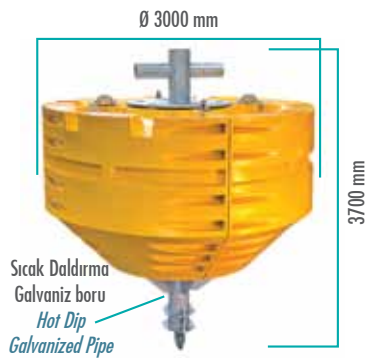

### MODÜLER SİSTEM / MODULAR SYSTEM

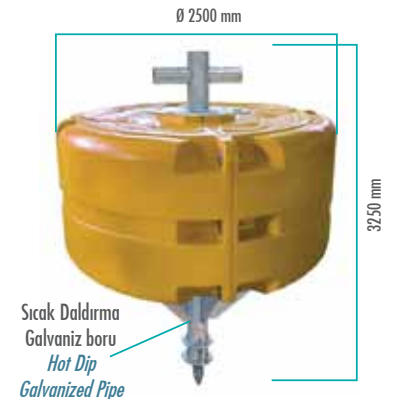



## M76000 (Ø 3000 mm) IALA DENİZ ŞAMANDIRALAMA SİSTEMİ / IALA BUOYAGE SYSTEM

IALA isteklerine göre renklerde üretilen şamandıraların içi eps veya poliüretan ile dolu, dışı ise polietilendir. Sert deniz şartlarına uygun olarak tasarlanmıştır. Yüzen polietilen kısım herhangi bir zarar görme durumunda kolaylıkla değiştirilebilecek dört çeyrek modüler parçadan oluşmaktadır. Şamandıra yüksekliği modüler tasarımı sayesinde isteğe göre üretilebilmektedir. Şamandıralara istenildiği taktirde güneş paneli, racon, ais, meteoroloji/ hidroloji sensörleri, akü ve şarj ünitesi gibi aksesuarlar eklenebilmektedir.

*High visibility red, green, white, yellow or blue as per IALA recommendations . Designed for harsh sea conditions.*

*Four quarters made in polyethylene filled with EPS or PU*

*Additional Equipments: Solar panel, racon, ais, meteorology/hydrology sensor, battery, charging unit etc.*

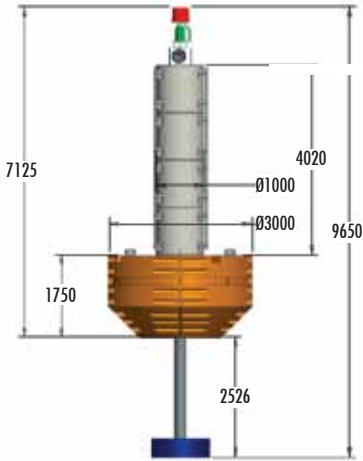

ÖLÇÜLER VE TEKNİK DETAYLAR / TECHNICAL DATA



GÜNEŞ PANELİ  
SOLAR PV SYSTEM



M03451  
RADAR REFLEKTÖRÜ  
RADAR REFLECTOR



M850  
3 to 6NM



M650H  
3 to 4+NM



M550  
1 to 3 NM

GÜNEŞ ENERJİLİ LED FENERLER  
SELF-CONTAINED LANTERNS



AIS SEYİR YARDIMCISI  
AIS for AtoN



RACON

### LATERAL İŞARETLEMELİ / LATERAL MARKS

A	76001		
A	76002		
A	76003		
A	76004		
B	76005		
B	76006		
B	76007		
B	76008		

### KARDİNAL İŞARETLEMELİ / CARDINAL MARKS

76009		
76010		
76011		
76012		

### TECRİT İŞARETLEMELİ / ISOLATED DANGER MARK

76013		
-------	--	--

### GÜVENLİ SU İŞARETLEMELİ / SAFE WATER MARK

76014		
-------	--	--

### ÖZEL İŞARETLEMELİ / SPECIAL MARK

76015		
-------	--	--

### GEMİ ENKAZI İŞARETLEMELİ / EMERGENCY WRECK MARK

76016		
-------	--	--

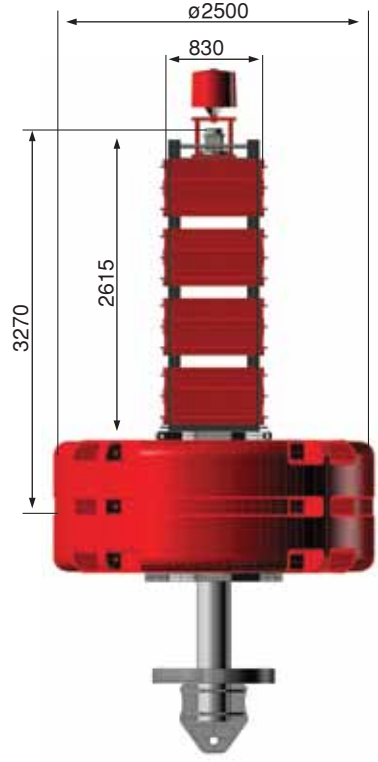

#### ÖLÇÜLER VE TEKNİK DETAYLAR / TECHNICAL DATA

Ø: 2500 mm  
Deniz suyundan fenerin görünme yüksekliği: 3270 mm  
Not : Şamandıranın denizden fenere yüksekliği modüler parçalar sayesinde ayarlanır  
Dış yapı : Polietilen  
İç Yapı : EPS veya Poliüretan  
Metal yapı : Sıcak daldırma galvaniz, alüminyum veya krom  
Focal Plane Height : 3270 mm  
Note: The Lantern focal height is adjustable with modular parts.  
Raw material : UV-stabilised virgin polyethylene  
Filling : EPS veya Poliüretan /EPS or PU  
Metal structure : Hot Dip galvanized, aluminum or stainless steel

#### M75500 (Ø 2500 mm) IALA DENİZ ŞAMANDIRALAMA SİSTEMİ / IALA BUOYAGE SYSTEM

IALA isteklerine göre belirlenen renklerde üretilen şamandıraların içi eps veya poliüretan ile dolu, dışı ise polietilendir. Sert deniz şartlarına uygun olarak tasarlanmıştır. Yüzen polietilen kısım herhangi bir zarar görme durumunda kolaylıkla değiştirilebilecek dört çeyrek modüler parçadan oluşmaktadır. Şamandıra yüksekliği modüler tasarım sayesinde isteğe göre üretilmektedir.  
High visibility red, green, white, yellow or blue as per IALA recommendations .  
Designed for harsh sea conditions.Four quarters made in polyethylene filled with EPS or PU



GÜNEŞ PANELİ  
SOLAR PV SYSTEM



M03451  
RADAR REFLEKTÖRÜ  
RADAR REFLECTOR



M850  
3 to 6 NM



M650H  
3 to 4+NM



M550  
1 to 3 NM

GÜNEŞ ENERJİLİ LED FENERLER / SELF-CONTAINED LANTERNS



AIS SEYİR YARDIMCISI  
AIS for AtoN



RACON

#### LATERAL İŞARETLEMELİ / LATERAL MARKS

A	75501		
A	75502		
A	75503		
A	75504		
B	75505		
B	75506		
B	75507		
B	75508		

#### IALA DENİZ ŞAMANDIRALAMA SİSTEMİ RENK VE TEPELİK SEÇENEKLERİ / IALA BUOYAGE SYSTEM COLOR AND TOP MARKS

#### KARDİNAL İŞARETLEMELİ / CARDINAL MARKS

75509		
75510		
75511		
75512		

#### TECRİT İŞARETLEMELİ / ISOLATED DANGER MARK

75513		
-------	--	--

#### GÜVENLİ SU İŞARETLEMELİ / SAFE WATER MARK

75514		
-------	--	--

#### ÖZEL İŞARETLEMELİ / SPECIAL MARK

75515		
-------	--	--

#### GEMİ ENKAZI İŞARETLEMELİ / EMERGENCY WRECK MARK

75516		
-------	--	--



## M75000 (Ø 2200 mm) IALA DENİZ ŞAMANDIRALAMA SİSTEMİ / IALA BUOYAGE SYSTEM

IALA isteklerine göre renklerde üretilen şamandıraların içi eps veya poliüretan ile dolu, dışı ise polietilendir. Sert deniz şartlarına uygun olarak tasarlanmıştır. Şamandıra birbirinden farklı renklendirilebilen modüler parçalardan üretilmektedir. Demirleme ve tonozlama için güçlendirilmiş bağlantı noktaları vardır. Şamandıranın üst kısmı her marka ve model deniz fenerine uyumludur. Şamandıralara istenildiği takdirde güneş paneli, racon, ais, meteoroloji sensörleri, akü ve şarj ünitesi gibi aksesuarlar eklenebilmektedir.

*High visibility red, green, white, yellow or blue as per IALA recommendations. Designed for harsh sea conditions. Modular parts with individual colors. Supported connection holes for mooring. The Top fits to every marine lantern or day signal.*

*Additional Equipments: Solar panel, racon, ais, meteorology/hydrology sensor, battery, charging unit etc.*

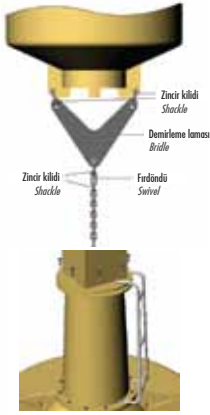
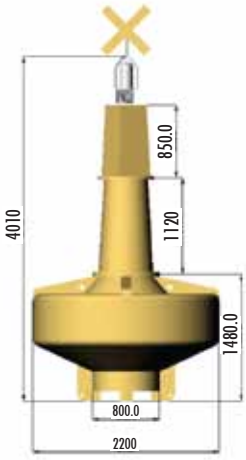

GÜNEŞ PANELİ  
SOLAR PV SYSTEM



M03451  
RADAR REFLEKTÖRÜ  
RADAR REFLECTOR



M850  
3 to 6NM



M650H  
3 to 4+NM



M550  
1 to 3 NM



AIS SEYİR YARDIMCISI  
AIS for AtoN



RACON

### ÖLÇÜLER VE TEKNİK DETAYLAR / TECHNICAL DATA

#### LATERAL İŞARETLEMELİ / LATERAL MARKS

A	75001		
A	75002		
A	75003		
A	75004		
B	75005		
B	75006		
B	75007		
B	75008		

### IALA DENİZ ŞAMANDIRALAMA SİSTEMİ RENK VE TEPELİK SEÇENEKLERİ / IALA BUOYAGE SYSTEM COLOR AND TOP MARKS

#### KARDİNAL İŞARETLEMELİ / CARDINAL MARKS

75009		
75010		
75011		
75012		

#### TECRİR İŞARETLEMELİ / ISOLATED DANGER MARK

75013		
-------	--	--

#### GÜVENLİ SU İŞARETLEMELİ / SAFE WATER MARK

75014		
-------	--	--

#### ÖZEL İŞARETLEMELİ / SPECIAL MARK

75015		
-------	--	--

#### GEMİ ENKAZI İŞARETLEMELİ / EMERGENCY WRECK MARK

75016		
-------	--	--



**M74000 (Ø 1750 mm) IALA**  
**DENİZ ŞAMANDIRALAMA SİSTEMİ**  
**IALA BUOYAGE SYSTEM**

**M73500 (Ø 1500 mm) IALA**  
**DENİZ ŞAMANDIRALAMA SİSTEMİ**  
**IALA BUOYAGE SYSTEM**

IALA isteklerine göre renklerde üretilen şamandıraların içi eps veya poliüretan ile dolu, dışı ise polietilendir. Sert deniz şartlarına uygun olarak tasarlanmıştır. Şamandıra birbirinden farklı renklendirilebilen modüler parçalardan üretilmektedir. Demirleme ve tonozlama için güçlendirilmiş bağlantı noktaları vardır. Şamandıranın üst kısmı her marka ve model deniz fenerine uyumludur.

Şamandıralara istenildiği taktirde güneş paneli, racon, ais, meteoroloji sensörleri, akü ve şarj ünitesi gibi aksesuarlar eklenebilmektedir.

*High visibility red, green, white, black, yellow or blue as per IALA recommendations. Designed for harsh sea conditions. Modular parts with individual colors. Supported connection holes for mooring. Top end fits to every marine lantern or day signal.*

*Additional Equipments: Solar panel, racon, ais, meteorology / hydrology sensor, battery, charging unit etc.*

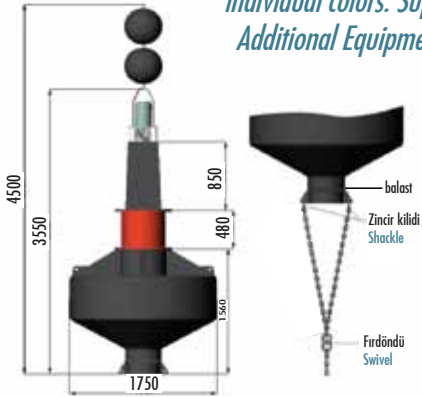

**ÖLÇÜLER VE TEKNİK**  
**DETAYLAR / TECHNICAL DATA**

**LATERAL İŞARETLEMELİ / LATERAL MARKS**

A	74001 73501		
A	74002 73502		
A	74003 73503		
A	74004 73504		
B	74005 73505		
B	74006 73506		
B	74007 73507		
B	74008 73508		



**M850**  
3 to 6NM



**M650H**  
3 to 4+NM



**M03451**

**RADAR REFLEKTÖRÜ**  
**RADAR REFLECTOR**



**M550**  
1 to 3 NM

**GÜNEŞ ENERJİLİ LED FENERLER**  
**SELF-CONTAINED LANTERNS**



**AIS SEYİR YARDIMCISI**  
**AIS for AtoN**



**GÜNEŞ PANELİ**  
**SOLAR PV SYSTEM**



**RACON**

**IALA DENİZ ŞAMANDIRALAMA SİSTEMİ RENK VE TEPELİK SEÇENEKLERİ / IALA BUOYAGE SYSTEM COLOR AND TOP MARKS**

**KARDİNAL İŞARETLEMELİ / CARDINAL MARKS**

74009 73509		
74010 73510		
74011 73511		
74012 73512		

**TECRİT İŞARETLEMELİ / ISOLATED DANGER MARK**

74013 73513		
----------------	--	--

**GÜVENLİ SU İŞARETLEMELİ / SAFE WATER MARK**

74014 73514		
----------------	--	--

**ÖZEL İŞARETLEMELİ / SPECIAL MARK**

74015 73515		
----------------	--	--

**GEMİ ENKAZI İŞARETLEMELİ / EMERGENCY WRECK MARK**

74016 73516		
----------------	--	--



## M03210 (Ø 1360 mm) IALA DENİZ ŞAMANDIRALAMA SİSTEMİ IALA BUOYAGE SYSTEM

IALA isteklerine göre renklerde üretilen şamandıraların içi eps veya poliüretan ile dolu, dışı ise polietilendir. Şamandıranın içinden isteğe bağlı sıcak daldırma galvaniz mil veya krom mil geçirilmektedir. Bu mil şamandıranın alt ve üstünde flanş ile sonlanmaktadır.

Üst kısma istenen tepelik işareti veya fener için flanş, alt kısımda tonoz bağlantısı için firdöndü mevcuttur.

Red, green, yellow, white, blue or black as per IALA Recommendations. Designed for harsh sea conditions. Modular parts with individual colors. Hot dipped galvanized or stainless steel shaft through the body. Flange for top mark and light at upper end, swivel for mooring at bottom end.



## M73000 (Ø 1250 mm) IALA DENİZ ŞAMANDIRALAMA SİSTEMİ IALA BUOYAGE SYSTEM

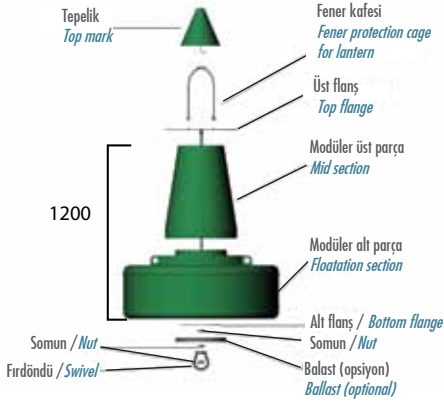

### ÖLÇÜLER VE TEKNİK DETAYLAR / TECHNICAL DATA

#### LATERAL İŞARETLEMELİ / LATERAL MARKS

A	73001 03211		
A	73002 03212		
A	73003 03213		
A	73004 03214		
B	73005 03215		
B	73006 03216		
B	73007 03217		
B	73008 03218		

#### IALA DENİZ ŞAMANDIRALAMA SİSTEMİ RENK VE TEPELİK SEÇENEKLERİ / IALA BUOYAGE SYSTEM COLOR AND TOP MARKS

#### KARDINAL İŞARETLEMELİ / CARDINAL MARKS

73009 03219		
73010 03220		
73011 03221		
73012 03222		

#### TECRİT İŞARETLEMELİ / ISOLATED DANGER MARK

73013 03223		
----------------	--	--

#### GÜVENLİ SU İŞARETLEMELİ / SAFE WATER MARK

73014 03224		
----------------	--	--

#### ÖZEL İŞARETLEMELİ / SPECIAL MARK

73015 03225		
----------------	--	--

#### GEMİ ENKAZI İŞARETLEMELİ / EMERGENCY WRECK MARK

73016 03226		
----------------	--	--

# MODÜLER PE FENER KULESİ *MODULAR ONSHORE PE TOWER AND MAST*



Patented

## MODÜLER PE FENER KULESİ ve AKSESUARLARI / *MODULAR ONSHORE PE TOWER AND MAST ACCESSORIES*

Marina, mendirek, iskele vb. kıyı şeritlerinde kullanılır. Tamamen modüler polietilen malzemeden dizayn edilmiştir.

Yanlarında bulunan merdivenler sıcak daldırma galvanizdir. Fener kulelerin üzerine güneş paneli, racon, ais, meteoroloji/hidroloji sensörleri, akü, şarj ünitesi gibi aksesuarlar ekleyebilirsiniz.

*The tower is made from modular polyethylene parts reinforced with steel parts*

*Additional Equipments: Solar panel ,racon, ais, meteorology / hydrology sensor ,battery, charging unit etc.*



MOPK12

PE ÖZEL İŞARETLEME DİREKLERİ  
*PE JETTY MASTS*

Dış Çap / *Outer Diameter* : 12 cm  
Yükseklik / *Height* : 300 cm

### MODÜLER PE PARÇALARI *MODULAR PE PARTS*



MOPK60

Dış Çap / *Outer Diameter* : 60 cm  
Yükseklik / *Height* : 75 cm



MOPK100

Dış Çap / *Outer Diameter* : 100 cm  
Yükseklik / *Height* : 100 cm



GALVANİZLİ YAN MERDİVEN  
PV GÜNEŞ ENERJİ SİSTEMİ  
*STEEL LADDER / SOLAR PV SYSTEM*



RACON



GÜNEŞ ENERJİLİ LED FENER  
*SELF-CONTAINED LANTERNS*



AIS SEYİR YARDIMCISI  
*AIS for AtoN*



## M60060 DİREK TİPİ ŞAMANDIRALAR / PILLAR/SPAR BUOYS

Dar kanallarda kullanılır. Su üstü tamamen modüler polietilen malzemeden dizayn edilmiştir. Yanlarında bulunan merdivenler sıcak daldırma galvanizdir. Su altında şamandırası ve çelik konstrüksiyonu ile tonozla bağlıdır.

*For Narrow Channels. Upper Part made from PE. Hot dip galvanized ladder. Pillar/Spar Buoy is tied up to the weight with buoy which is underwater and steel construction.*

## M60040 DİREK TİPİ ŞAMANDIRALAR / PILLAR/SPAR BUOYS

Dar kanallarda kullanılır. Tamamen modüler polietilen malzemeden dizayn edilmiştir. İç yapısı sıcak daldırma galvanizdir. Balast ile dengede kalması sağlanmaktadır.

*For Narrow Channels. Upper Part made from PE. The inner structure is hot-dip galvanized. It is ensured to stay in balance with ballast.*

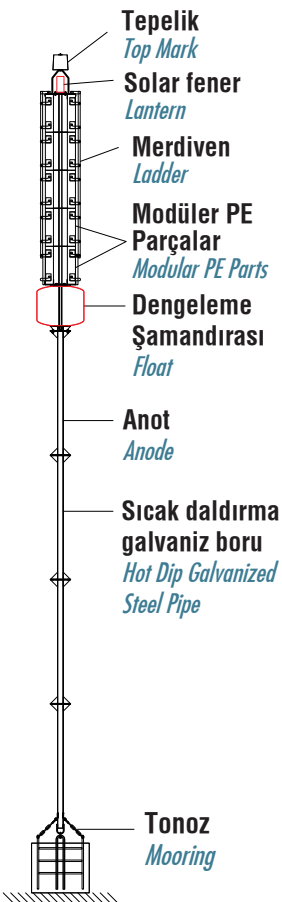

**M850**  
3 to 6NM



**M650H**  
3 to 4+NM



**M550**  
1 to 3 NM

**GÜNEŞ ENERJİLİ LED FENERLER**  
**SELF-CONTAINED LANTERNS**

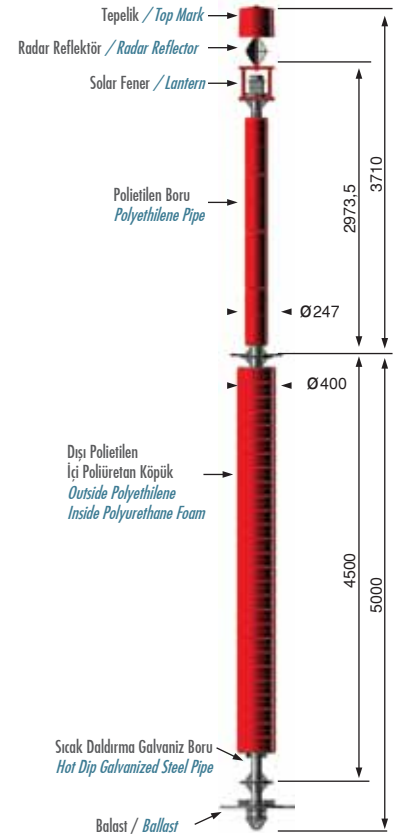

Patented

## PE YÜZDÜRÜCÜLER / PE FLOATERS



En / Width : 100  
Boy / Length : 100  
Yükseklik / Height : 40 cm  
Yüzdürmesi / Buoyancy : 300 kg

### M03000

Patentli kilit sistemi sayesinde herhangi bir metal konstrüsyona yada yüzey kaplamasına gerek duymadan da kullanılabilir.

Metal konstrüsyonlu yüzer iskelelerde de kullanılan bu yüzdürücü istenildiği takdirde üst üste konularak iskele yüksekliği artırılabilir.

Alttaki 4 adet kova şeklinde boşluklar sayesinde ürünün su yüzeyine tutunması artmaktadır. Buda ürüne stabilite ve sağlamlık kazandırmaktadır.

*The M03000 can be used without any metal construction or surface coating thanks to its patented locking system. This floater which can also be used with floating docks with metal construction also allows height increase by simply being stacked one on another. The bucket shaped gaps located at the bottom gives the product more stability and strength.*



En / Width : 100  
Boy / Length : 100  
Yükseklik / Height : 116 cm  
Yüzdürmesi / Buoyancy : 1000 kg

### M03002

M03002 modeli 1000 kg yüzdürmesiyle daha fazla kaldırma kuvveti gerektiren ve daha yüksek yüzer iskele çözümleri için kullanılmaktadır. İçine EPS veya PU basımı yapılarak bir kazaya uğraması sonucu içine su girse bile yüzmeye hala devam etmesi sağlanmaktadır.

*With its 1000kg buoyancy the M03002 is used for floating dock solutions which require more buoyancy and more height. The EPS or PU injection inside the product enables it to continue floating even after being flooded after impact.*



En / Width : 36  
Boy / Length : 337  
Yükseklik / Height : 37 cm  
Yüzdürmesi / Buoyancy : 300 kg

### M03003

Özellikle kano iskelelerinde düşük fribord istenmesinden dolayı dizayn edilmiştir. Bunun yanı sıra yakın kıyısal yüzer iskeleler ve kare kafes balık çiftliği projelerinde hem yürüme yolu hem de kafes olarak kullanılmaktadır. Üzerine her türlü modül (kulübe, jeneratör, vinç, pedestal, vb) monte edilebilir. İstenmesi durumunda içine EPS veya PU basılmaktadır.

*The design is based on the low freeboard requirement especially in canoe docks. Besides, the product is used in coastal floating docks and also in square caged fish farms both as walkways and cages. All kinds of facilities (cabins, generators, cranes, pedestals and etc.) may be mounted on. EPS or PU injections are available upon request.*





**M03005** BOT ve JETSKI PARK PLATFORMU / *BOAT AND JET SKI PARKING PLATFORM*

## AKSESUAR VE EKİPMANLAR / *ACCESSORIES AND EQUIPMENTS*



**KOÇ BOYNUZU** / *DECK CLEAT*



**YÜRÜME YOLU** / *GANGWAY*



**EMPRENYE AHAŞAP** / *IMPREGNATED WOOD*



**GÜNEŞ ENERJİLİ LED AYDINLATMA**  
*SOLAR POWERED LED LIGHTING*





**M**artek Endüstri Malzemeleri San. ve Tic. Ltd. Şti.  
1994 yılında İzmir'de faaliyete başlamıştır.  
Bugün İzmir Kemalpaşa'daki 12000 m<sup>2</sup> açık 5000 m<sup>2</sup>  
kapalı alana sahip fabrikasında üretimine devam etmektedir.  
*Martek has been founded in 1994 in Izmir. Today,  
its factory which has 12000 m2 open and 5000 m2 close area,  
is located at Kemalpaşa, Izmir.*



#### Kalite Politikamız

Sağlıklı, güvenli bir çalışma ve çevre ortamı içerisinde yüksek moral değerlerine sahip eğitilmiş personelle çalışmak.  
Çevre ve toplum sağlığına zararsız olduğu kanıtlanan ürünleri araştırıp bunların imalat ve satış lisanslarını çıkarmak.

İmalat için en nitelikli hammadde ve yan sanayi ürünlerini temin etmek.

Müşteri/Bayi şikayetlerini değerlendirerek düzeltici/önleyici faaliyetlerde bulunarak standart, kanun ve tüzüklere uygun üretim yapmak,  
müşteri tatminini üst düzeyde tutmak. Müşteri/Bayi taleplerini zamanında, güvenilir ve en ekonomik şekilde karşılayıp  
müşteri/bayi ile yapılan sözleşmeye uygun olarak istenilen miktarda, kalitede, terimde ürün sunmak.

Sağlıklı ve güvenli bir çevrede eğitilmiş personelle ürettiğimiz ürünlerle firmamızın pazar payını artırarak rekabet şansımızı yükseltmek.

Sürekli iyileştirme çevrimi içerisinde ürünlerimizi ilk defada istenen standart ve kalitede üretmek.

Yaptığımız ürünlerin bir gün bizim de kullanabileceğimizi bilerek imalatını yapmak.

*With our growing product range and customer portfolio,*

*Martek have been carrying on its new projects in order to cover needs of marine market with high quality.*

*Since the company has been founded, we aim to be different in view, to provide customer satisfaction and to have innovative thought.*

*Thus we have achieved to be the preferred and growing brand in a short time with wide range of products As a result of giving  
the utmost importance to the research and development departments, our role in the market becomes bigger.*

*Our high quality and wide range of products opens new market opportunities and our development leads us to the international markets.*

*Our Policy of Quality Working in a secure and healthy environment with highly motivated,  
well educated staff who have strong devotion to the firm and the job they do.*

*Using best raw materials and sub-contractor products for best quality production.*

*Appreciating customer complaints, performing corrective/ preventive activities and keeping customer satisfaction at maximum level.*

*Meeting the customer orders on time and in the most economical way. Supplying customers' orders exactly as per sales contract.*

*Increasing the market share in order to be competitive by giving the importance to creative thought and research-development activities.*

*Being aware of the recent technological developments, carrying the present product and service quality to the perfect*

# martek®

END. MAL. İNŞ. TURİZM. SAN. ve TİC. LTD. ŞTİ.



[www.martek.com.tr](http://www.martek.com.tr)



[info@martek.com.tr](mailto:info@martek.com.tr)



Tel: +90 (232) 877 14 84 • Fax: +90 (232) 877 14 49



Atatürk mah. 78 Sk. No.10 Ulucak - Kemalpaşa - İZMİR - TÜRKİYE



<https://www.facebook.com/martekotr>



<https://twitter.com/Martekcomtr>



<https://tr.pinterest.com/martekcomtr/>



<https://www.instagram.com/martekcomtr/>



<https://tr.linkedin.com/company/martek-end-mlz-san-vecic-ltd>